



BONDED ABRASIVES

ENGINEERING
SURFACES

PRODUCT
CATALOGUE



CARBORUNDUM UNIVERSAL LIMITED

ABOUT US

Carborundum Universal Limited (CUMI) is part of the US\$ 9.1 billion conglomerate Murugappa Group. The company pioneered the manufacture of Coated Abrasives and Bonded Abrasives in India. In addition, we also manufacture Super Abrasives, Super Refractories, Electro Minerals, Industrial Ceramics, Ceramic Fiber and Power Tools.

CUMI manufactures the complete range of Vitrified, Resinoid and Rubber Bonded Products for various industrial applications; Cylindrical Grinding, Centerless Grinding, Surface Grinding, Face Grinding and complete range of Coated Products: Abrasive Paper, Fibre Discs, Rolls, Flap Discs, Non-Woven and Flap Wheels.

Our products address various type of industries: Automobile OEM, Auto Components, Steel, Bearing and roll elements, Foundry, General Engineering, Aerospace.

CUMI's strong R&D and Application support team provide complete grinding system engineering and technical support to customers. With strategic global alliances, state of the art manufacturing facilities and sales support that span across North America, Europe, Russia, South Africa, India, China, Australia, Japan, Korea. CUMI has achieved a reputation for quality and innovation.

CUMI specializes and develops specific products to meet the requirements of customers and markets.

CUMI



BONDED
ABRASIVES

COATED
ABRASIVES

NON WOVEN
ABRASIVES







CUTTING AND
ABRASIVES

DIAMOND
ABRASIVES

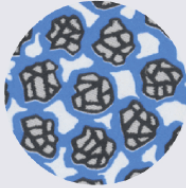
POWER
TOOLS



INDEX

S.NO.	MODULE		PG.NO.
1	INTRODUCTION		6
2	CENTERLESS GRINDING WHEELS		14
3	CYLINDRICAL GRINDING WHEELS		26
4	CRANKSHAFT GRINDING WHEEL		32
5	CAMSHAFT GRINDING WHEELS		36
6	F-TYPE GRINDING WHEELS (DOUBLE DISC)		41

INDEX

S.NO.	MODULE		PG.NO.
7	BORE GRINDING WHEELS		48
8	IR TRACK GRINDING WHEELS		52
9	THREAD GRINDING WHEELS		57
10	FLUTE GRINDING WHEEL		61
11	BALL GRINDING & LAPPING WHEELS		65
12	CREEP-FEED GRINDING WHEELS		71

INDEX

S.NO	MODULE		PG.NO.
13	GEAR GRINDING WHEELS		75
14	ROLL GRINDING WHEELS		84
15	SNAGGING WHEELS		88
16	CUP WHEEL GRINDING		93
17	TOOL ROOM GRINDING WHEELS		97

BONDED ABRASIVES

About Bonded Abrasives

Bonded abrasives is a terminology collectively used for a range of abrasive products where abrasive grains are held together by bonding materials moulded into various shapes like grinding wheels, segments, dressing sticks, mounted points etc.,

Grinding wheel is a multi point cutting tool composed of abrasive grains held together by bonding material (bond) and separated by voids. The abrasive grains provide the cutting points, which in turn helps in cutting the material to the required dimensional accuracy or help impart a fine surface finish. The arrangement of the abrasive grains and the bond in the grinding wheels gives a specific volume of pores know as 'structure'. These pores are designed based on application needs and provide chip clearance.

The major types of grinding are

(a) Precision Grinding (b) Non-Precision Grinding or Offhand Grinding

With latest developments in technology, we at CUMI pride ourselves in being one of the top manufacturers in the world for both precision and non-precision grinding applications. Our range of grinding wheels are used for various grinding applications that include Ball Grinding & Lapping, Crankshaft & Camshaft Grinding, Gear Grinding, Centerless Grinding, Cylindrical Grinding, Creep Feed Grinding, Thread Grinding, Flute Grinding, Roll Grinding, Bore Grinding, Track Grinding, Face Grinding and Surface Grinding.

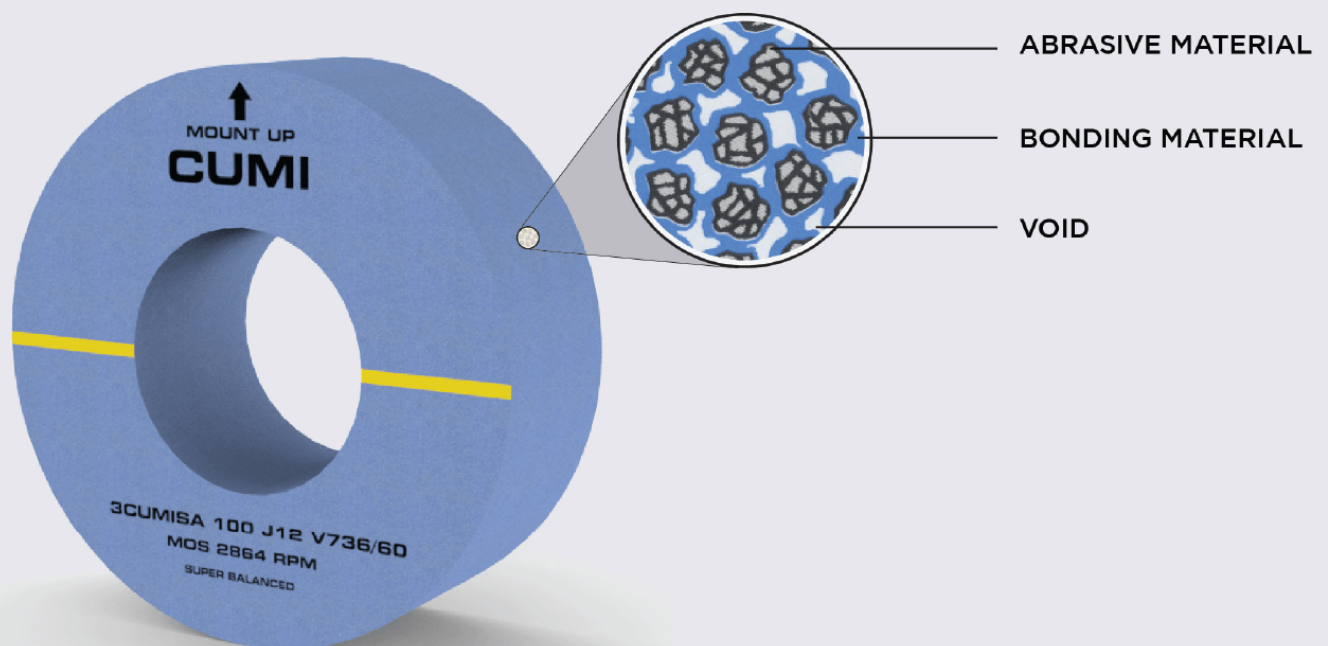

UNDERSTANDING THE NOMENCLATURE

CUMI BONDED ABRASIVES MARKING

A	46	3	L	5	V2016	/45
ABRASIVES TYPE	GRIT SIZE	GRIT COMBINATION	HARDNESS	STRUCTURE	BOND SYSTEM	WHEEL SPEED
Alumium Oxide						
A, AA, RA, RAA, SA, DA, HA, MCA, CUMISA	8, 10, 12, 14 16, 20, 24, 30 36, 46, 54, 60,		DEFGH IJKL			
Silicon Carbide	80, 100, 120,		MNOP			
C, GC, CGC	150, 180, 220, 240, 280, 320,	1 3 5 7	Q RST	1 2 3 4 5 6 7 8... ...UPTO 35	V - Vitrified B - Resinoid R - Rubber	
Zircon Alumina	400, 600, 800,		UVWX			
ZA	1200, 1500		YZ			

ABRASIVES GRAINS

A	46	3	L	5	V2016	/45
----------	-----------	----------	----------	----------	--------------	------------

An Abrasive is a mineral crystal with hardness much higher than that of work piece. An Abrasive grain cuts into the work until it becomes dull. Then it breaks down (fractures) and exposes new cutting edges.

The principle properties to be considered when choosing an abrasive are as follows:

- **HARDNESS** - Resistance to Penetration
- **TOUGHNESS** - Ability to Withstand Load
- **FRIABILITY** - Ability to Fracture Under Load
- **THERMAL CONDUCTIVITY** - Ability to Conduct Heat

GRAIN TYPE	CODE	PROPERTIES & APPLICATIONS
Brown Aluminium Oxide	A	Tough Grain for High Tensile Strength Materials
Semi Friable Aluminium Oxide	SA	Free Cutting Grain with Good form Holding for Complete Range of Steels
White Aluminium Oxide	AA	Pure Aluminium Oxide for Hardened or High Speed Steels
Premium Aluminum Oxide	9A	Free cutting with better form holding for a competitive range of sheets
Pink Aluminium Oxide	RA	Friable Grain for Alloyed and Chromium Based Materials
Pink Aluminium Oxide Blend	RAA	Combination of Pink and White Aluminium Oxide Grains for Added Advantage
Ruby Pink Aluminium Oxide	24R	Tough Pink Grain for Improved form Retention
Brown and White Aluminium Oxide Blend	DA	Combination of White and Brown Aluminium Oxide Grains for Dual Advantage
Friable Aluminium Oxide	SBA	Friable Grain for Improved Dressing
Pure Aluminium Oxide	12A	Premium Grain for High Performance
Premium Aluminium Oxide Blend	65A	For Best All Round Performance in Cylindrical Applications
Sharp Premium Aluminium Oxide Blend	50A, 50MA, 53MA	Sharp and Pure Aluminium Oxide Grains for Grinding Hard Materials
Sharp Crystal Aluminium Oxide	70A	Sharp Crystalline Grain Combination of Premium Performance on all Materials
Micro Crystalline Grains	CUMISA	Sharp Ceramic Grain for High MRR & GR Requirements
Micro Crystalline Grains	CSA	Sharp ceramic grains with very good MRR and GR
Micro Crystalline Grains	CN	Sharp ceramic grains for superior performance requirements
Micro Crystalline Grains	CE	Sharp ceramic grains for very high MRR
Black Silicon Carbide	C	Hard and Friable Grain for Non Ferrous Material, Cast Iron and Stainless Steel
Green Silicon Carbide	GC	Hard and Friable Grain for Per Grinding Cemented Carbide Tools, Hard Chilled Cast Iron Rolls etc
Silicon Carbide Blend	CGC	Combination of C & GC
Silicon Carbide and Aluminium Oxide Blend	CA	Combination of Aluminium Oxide & Silicon Carbide for Alloy Steel and Stainless Steel
Zirconia Alumina	AZA	Alumina Zirconia Alloy - Hard & Tough Grain for Very High Performance

GRIT SIZE

A	46	3	L	5	V2016	/45
---	-----------	---	---	---	-------	-----

The size of the abrasive is expressed by the size of the screen opening through which the grains are shifted or sorted. For instance. A grain or grit which goes through a screen 8 mesh or openings per linear inch is called 8 grain or grit size, while a 24 grit size, while a 24 grit size is roughly twenty fourth of an inch across. The higher the grit size, the finer its type.

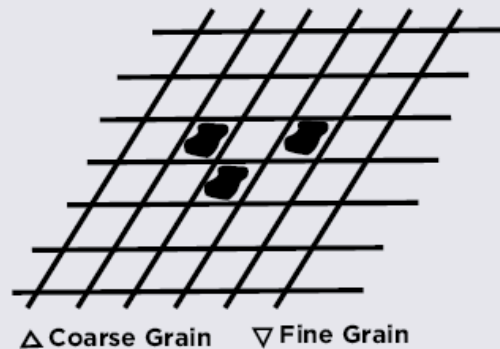

30 Grit	.0232" Square Hole
60 Grit	.0098" Square Hole
120 Grit	.0035" Square Hole

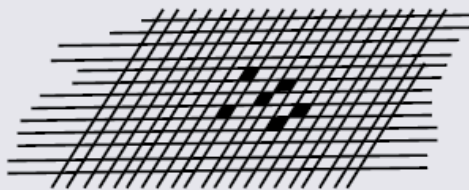
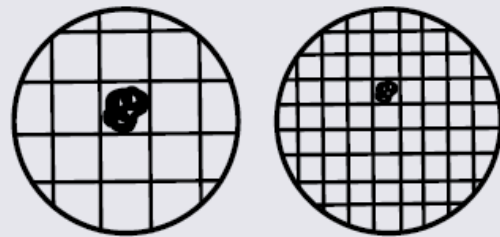

Grading of Abrasives

GRIT COMBINATION

A	46	3	L	5	V2016	/45
---	----	----------	---	---	-------	-----

- Combination of Different Grit sizes in Predetermined Percentages
- Ex. A463 L5 V10 - Combination of 46, 54 & 60 Grits. Primary Grit 46 will be at Higher Percentage.

GRADE HARDNESS

A	46	3	L	5	V2016	/45
---	----	---	----------	---	-------	-----

Grade Hardness is the volume of the bond present in the wheel.

For a wheel of a particular bond type, the amount of bond used in the wheel mainly determines its hardness. When the amount of bond is increased, the size of the bond posts connecting each abrasive grain to its neighbours is also increased. The larger bond post is naturally stronger, thereby increasing the wheel's hardness.

Grade hardness is therefore not a measure of the hardness of the abrasive, but of the durability of the wheel. A hard abrasive can be bonded into a soft, free cutting wheel by using less bond, while an increase in the amount of bond can make the wheel act harder. Wheel grading range from D for the softest, to Z+ for the hardest.

STRUCTURE

A	46	3	L	5	V2016	/45
---	----	---	---	----------	-------	-----

Structure is an indication of the abrasive grains in a wheel. This is defined by the voids or spaces between the abrasive grain and the bonding material and is called wheel porosity. A close structured wheel is one, where the volume of closely packed grains are more. These are given structured numbers of 1 and 2. Conversely. Open structure wheels are those with wider grain spacing.

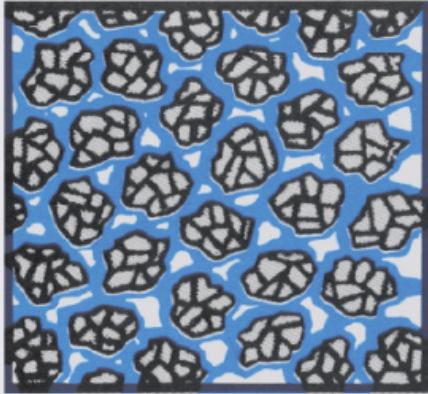

Dense Spacing

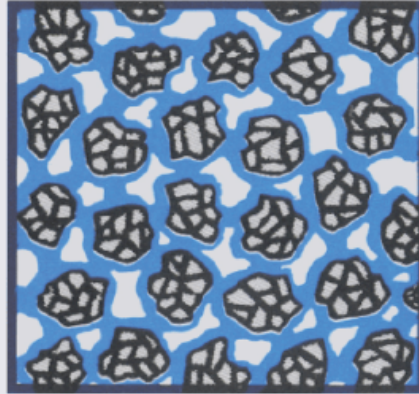

Medium Spacing

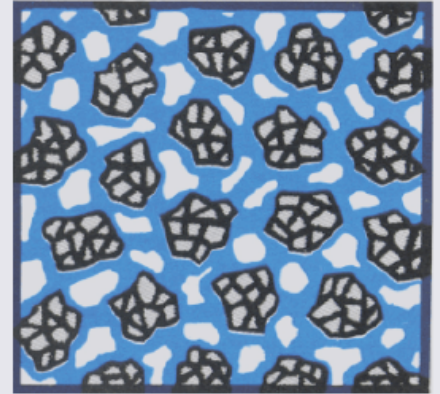

Open Spacing

Spacing of abrasive measured in volume of abrasive particles - higher the number, more porous the wheel structure.

5 = Normal Porosity, 3 = Dense, 7 = Porous

DESCRIPTION	OPEN STRUCTURE	CLOSED STRUCTURE
Material Removal Rate	High	Low
Grinding Ratio	Low	High
Area / Arc of Contact	High	Low
Severity of Operation	High	Low
Form Holding	Poor	Good
Wheel Speed	Low	High
Type of Operation	High Stock Removal, Creep Feed	Normal Stock Removal
Thermal Conductivity of Work Material	Low	High

BOND

A	46	3	L	5	V2016	/45
---	----	---	---	---	--------------	-----

VIRITIFIED BOND	RESINOID BOND	RUBBER BOND (R)
Glassy Bond Made of ingredients available Naturally	Made of phenolic thermo setting resins	Made of Natural / Synthetic Rubber
Very Brittle	Very Resilient - Can withstand Shock Loads	Batter Resilliency - Can withstand Shock Loads
Water, Chemical Resistance	Low Water, Chemical Resistance	Water, Chemical Resistance
Very Good for Retention	Good Form Retention	Good form Retention
No Restriction Shelf Life	Shelf life 1 - 2 years	No Restriction Shelf Life
Severity of Operation - Low	Severity of Operation - High	Severity of Operation - High
For Wheel Speeds upto 80 meters per sec	For Wheel Speeds upto 80 meters per sec	For Wheel Speed upto 45 meters per sec
Application for almost any kind of application	Gives cool cutting and is more suitable for application with high area of contact, High Material Removal Rate.	For applications where very fine surface finish is required

WHEELS SPEED

A	46	3	L	5	V2016	/45
---	----	---	---	---	-------	------------

Effect of wheel and work speed on grinding action

SPEED	INCREASED	DECREASED
Wheel speed	Harder	Softer
Work speed	Softer	Harder
Traverse speed	Softer	Harder
Infeed rate	Softer	Harder

WHEEL SPEED	COLOR BAND
33 / 35 mps	White Band
45 / 50 mps	Blue Band
60 / 63 mps	Yellow Band
80 mps	Red Band
100 mps	Green Band

WHEEL SELECTION

CUMI has one of the widest range of grinding wheels in the world. Available in standard size or customized to specific grinding requirements, these premier quality wheels are manufactured to suit the varied grinding needs of all user. Since there are as many types of wheels as there are grinding applications, correct wheel usage assumes very critical importance.

FACTORS AFFECTING THE SELECTION OF A GRINDING WHEEL

Wheel selection is dependent type of material to be ground and the type of grinding operation. The eight important factors that need to be considered in the selection of a grinding wheel are

1. Material to be ground and its hardness
2. Stock removal and surface finish
3. The grinding process-whether wet or dry
4. Peripheral speed of the wheel
5. The area of grinding contact-large or small
6. The severity of grinding operation
7. Condition of grinding machine
8. Type of grinding machine

STANDARD GRINDING WHEEL SHAPES

STRAIGHT WHEELS

Type 1, 5 & 7 wheels are standard for internal grinding, cylindrical grinding, tool grinding, off hand grinding and snagging. The recess in type NOs. 5 and 7 gives clearance for the mounting flanges.

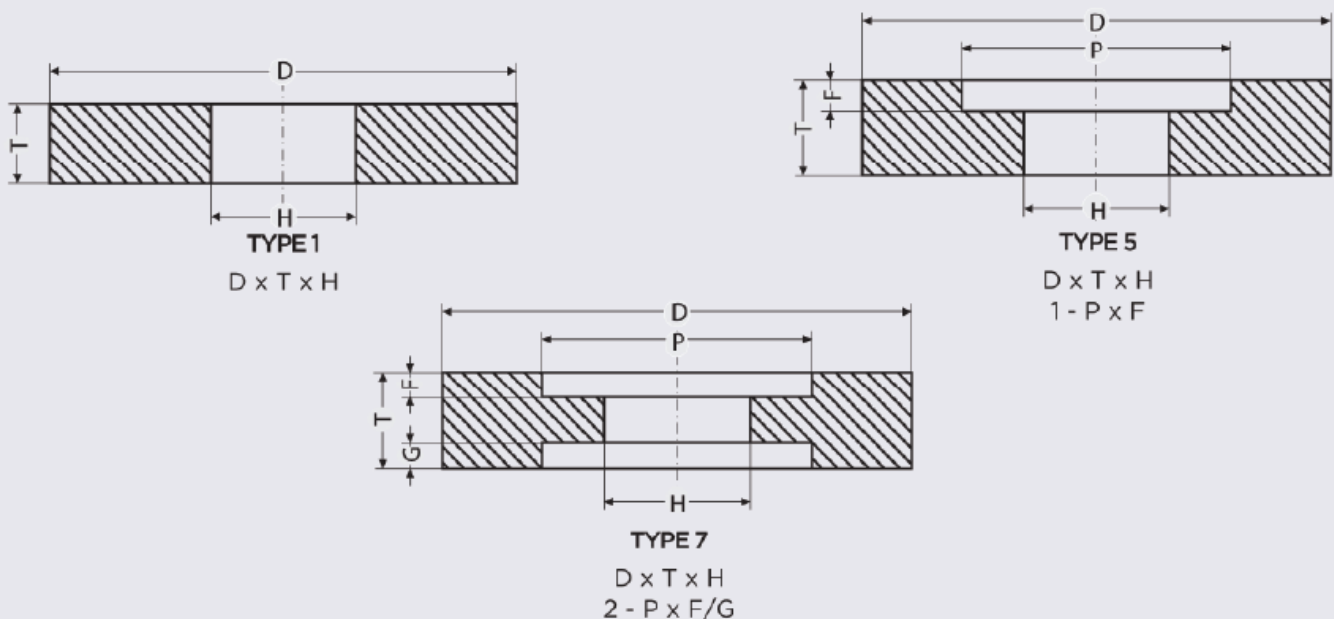

STANDARD GRINDING WHEEL SHAPES

TAPERED WHEELS

Type 4 wheels, is a modification on Type 1 wheel having a taper on both sides and is used principally in snagging operation. Tapered wheels with tapered mounting flanges are a safety device to prevent pieces of the wheel from flying out should the wheel break in operation.

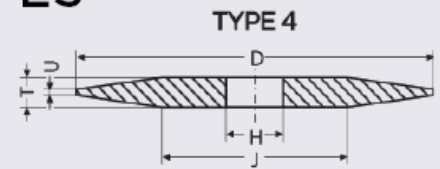

CYLINDER WHEELS

Type 2 wheels is used for surface grinding on both horizontal and vertical spindle machines with the grinding performed on the face of the wheel

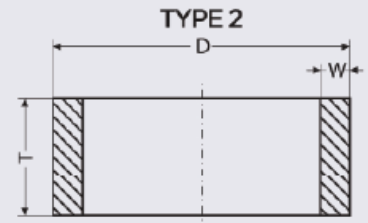

STRAIGHT CUP WHEELS

Type 6 wheel is a straight cup wheel and is used primarily for surface grinding on horizontal or vertical spindle machines. It is also useful for off-hand grinding in order to generate a flat surface. Available in either plain or bevel face.

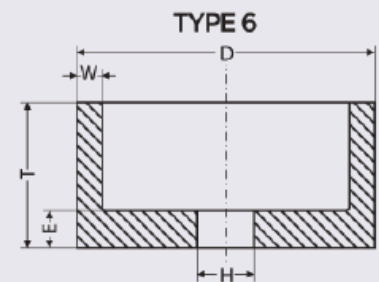

FLARING CUP WHEELS

Type 11 wheel is a flaring cup wheel used for grinding various surfaces requiring flatness. It is supplied with either a plain or bevelled face.

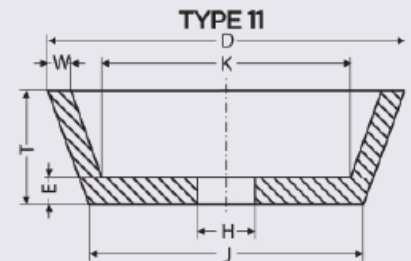

DISH WHEELS

Type 12 wheel is a dish wheel used for grinding in the tool room. Its thinness permits the insertion of the grinding edge of the wheel into narrow places.

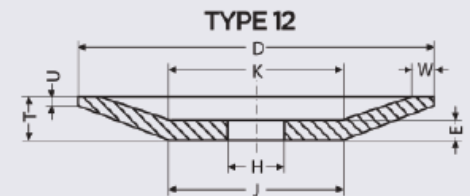

SAUCER WHEELS

Type 13 wheel is a saucer wheel or saw gummer. Its name derived from its use for re-sharpening saws (saw gumming)

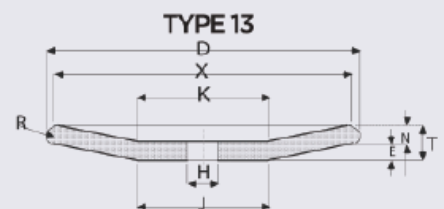

D: Diameter (overall)

E: Thickness at hole or back thickness

F: Depth of recess (see type 5 & 7)

G: Depth of recess (see type 7)

H: Hole

J: Diameter of outside flat

K: Diameter of inside flat

M : Large Diameter of bevel

P : Diameter of recess

R : Radius of corner

T : Thickness (overall)

U : Width of edge

W: Wall thickness of grinding face

STANDARD GRINDING WHEEL SHAPES

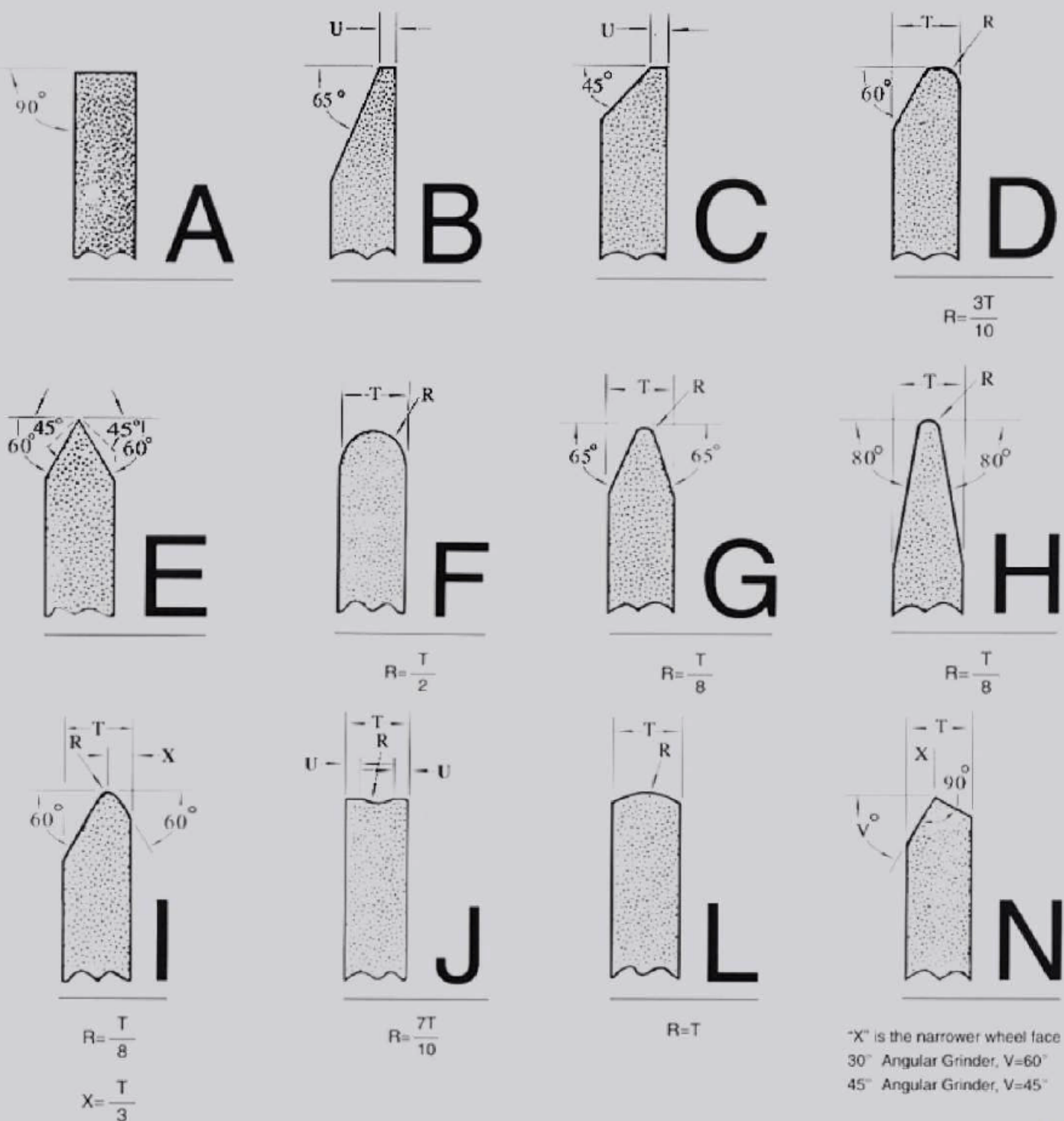

BONDED ABRASIVES

CENTERLESS GRINDING WHEELS

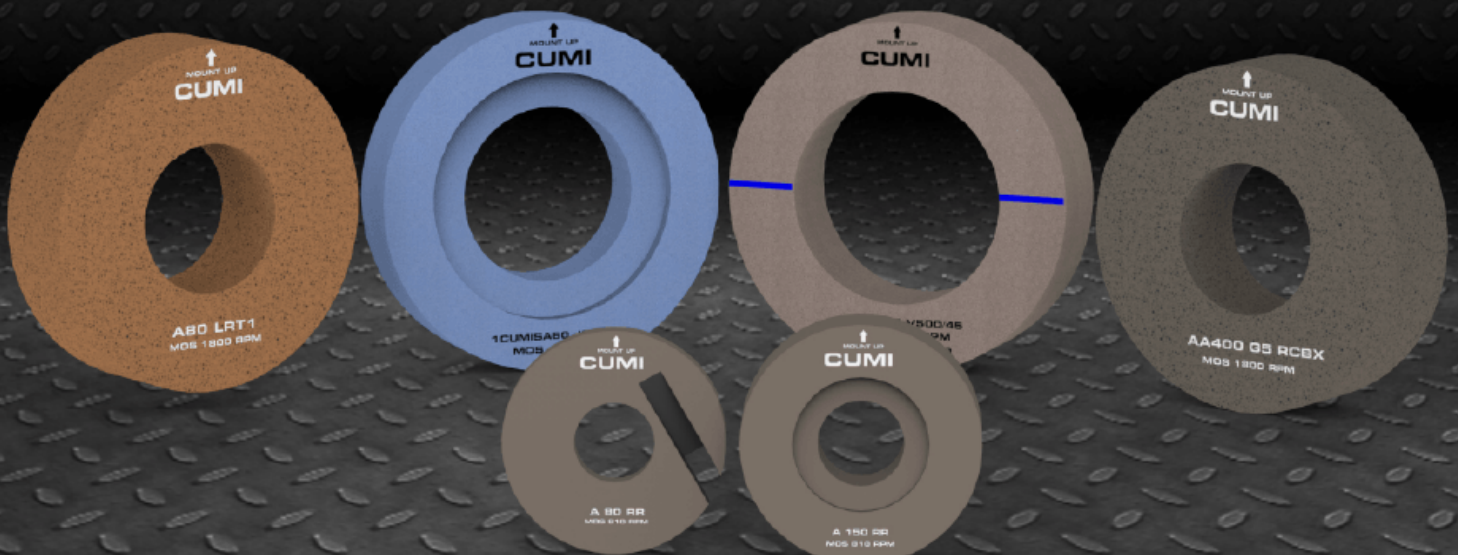

CENTERLESS GRINDING



BONDED ABRASIVES

CENTERLESS GRINDING WHEELS

ABOUT CENTERLESS GRINDING WHEELS

An application which presents the most daunting challenges to any abrasive manufacturer. The range of requirements and priorities of this application varies from product to product which calls for an equally wide range of offerings to suit the same. Since in most of the Centerless applications, more than one wheel is mounted on the spindle, extremely tight tolerances need to be maintained in the geometry and densities of the wheels to ensure uniform wear patterns even if each wheel in the set is different.

CUMI has the expertise, when it comes to Centerless applications thanks to the advanced manufacturing process, premium Abrasive grains and specially designed Vitrified, Resin and Rubber bond systems to suit the application needs. Customized solutions are provided for every application and specific requirement. Be it through-feed, end-feed or in-feed, CUMI wheels ensure that components are finished to stringent quality requirements.

FEATURES:

- Unique set of combination wheels for higher stock removal, good surface roughness and higher productivity
- Unique grain combination for specific application
- Cork bond for superior surface roughness & luster
- Wide range of bond system to customize individual grinding needs

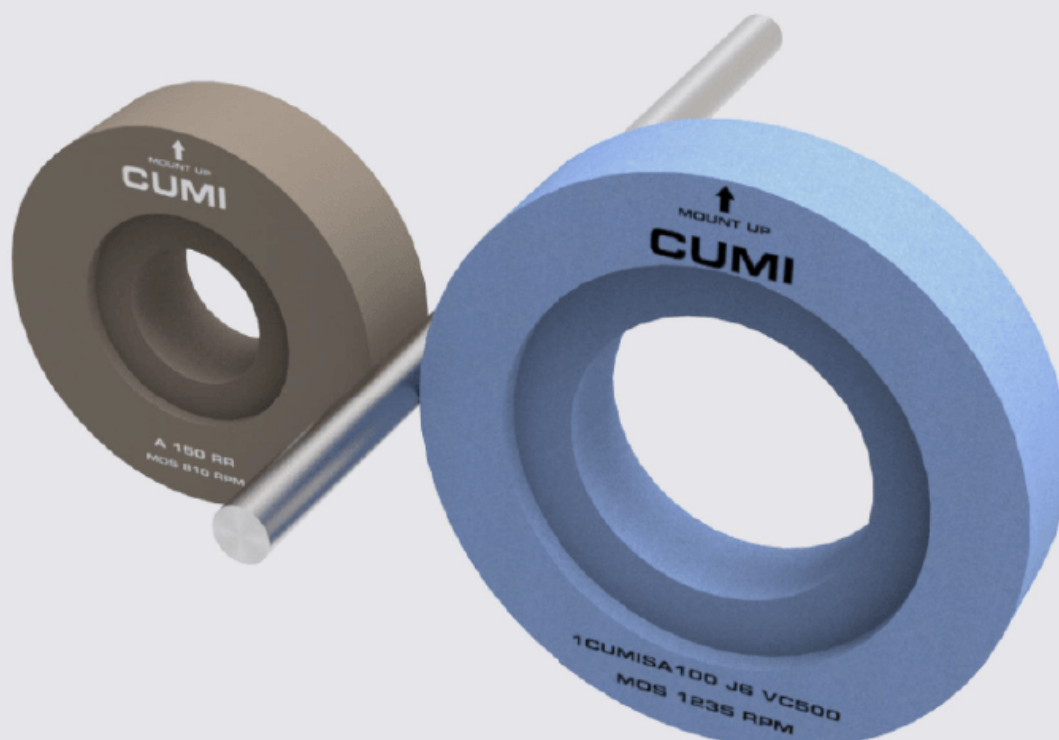

CENTERLESS GRINDING WHEELS

ADVANTAGES OF CUMI WHEELS

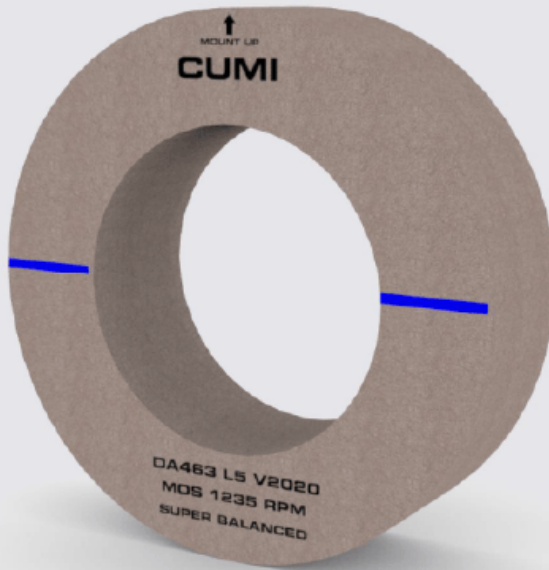

1. High stock removal
2. Lower dressing frequency
3. Burn free component
4. Better productivity
5. Excellent surface finish

WIDTH OF PRODUCT RANGE

CUMI Code	Grt Range	Diameter		Thickness		Hardness	Structure	Speed
		mm	Inch	mm	Inch			mps
CUMISA	46 - 120	350 - 610	14 - 24	100 - 250	4 - 10	I - N	6 & 8	35.50 & 63
50A / 50MA	46 - 120					I - N	7	35 & 50
65A	80-220					L	-	40
SA	46 - 120					I - N	5 - 7	35 & 50
9A	46 - 120					I - P	5 - 7	35 & 50
SBA	46 - 120					I - P	5 - 7	35 & 50
AA	46 - 120			I - N	5 - 7	35 & 50		
DA	46 - 120			I - P	5 - 7	35 & 50		
A	46 - 120			I - P	5 - 7	35 & 50		
C	46 - 120			I - N	5 - 7	35 & 50		
GC	46 - 120	I - N	5 - 7	35 & 50				

SHAPES



COMMONLY USED MACHINES

•Cincinnati •WMW •Marcus •Lid koping •Micron

VALVE STEM

Type	Operation	Speed	Best	Better	Good
Mono Valve (Inlet Valve)	Rough	35	9A463 M3 V887	A463 P5 V2020	A463 M3 V2018
		50	9A463 M3 V887/50	A463 P5 V2020/50	A463 M3 V2018/50
	Semi Finish	35	9A60 L5 V887	DA60 V2016	A60 L5 V2016
		50	9A60 L5 V887/50	DA60 V2016/50	A60 L5 V2016/50
	Finish	35	9A100 S5 V887	DA100 J5 V2016	A100 J5 V10C
		50	9A100 S5 V887/50	DA100 J5 V2016/50	A100 J5 V10C/50
Bi - Metal (Exhaust Valve)	Rough	35	9A463 M3 V887		
		50	9A463 M3 V887/50		
	Semi Finish	35	9A60 L5 V887		
		50	9A60 L5 V887/50		
	Finish	35	9A100 J5 V887		
		50	9A100 J5 V887/50		

*** Finishing Operation:**

For Roughness 0.3 Ra --> Use Grit 100

For Roughness < 0.3 Ra --> Use Grit 150



BEARING RING

Type	Operation	Speed	Best	Better	Good
Outer Diameter (TRB,SRB,CRB)	Rough & Finish	35			A463 L5 V10C
		50	55A54 I7 VC500/50 55A80 I7 VC500/50	DA54 I6 TDV876/50 DA80 I6 TDV876/50	A463 L5 V10C/50 A80 K5 V10C/50

Note: Special Wheels

Wheel Dimension	Operation	Speed	Best	Better	Good
Outer Diameter (Ball Bearing) 610 X 610 X 304.8 508 X 610 X 304.8 610 X 508 X 304.8	Roughing & Finishing	50	53MA461 J7 VC500/50	1CUMISA461 J6 VCAE/50	DA60 I6 TDV876
			53MA541 J7 VC500/50	1CUMISA541 J6 VCAE/50	DA80 I6 TDV876
			53MA601 J7 VC500/50	1CUMISA601 J6 VCAE/50	-
			53MA801 J7 VC500/50	1CUMISA801 I6 VCAE/50	-
	Roughing & Finishing	63	53MA461 J7 VC500/63	1CUMISA461 J6 VCAE/63	-
			53MA541 J7 VC500/63	1CUMISA541 J6 VCAE/63	-
			53MA601 J7 VC500/63	1CUMISA601 J6 VCAE/63	-
			53MA801 J7 VC500/63	1CUMISA801 I6 VCAE/63	-
Outer Diameter (Railway Bearing) 610 X 864X 304.8	Roughing & Finishing	35	RAA60 J+4 V2016	-	-
			RAA80 J+4 V2016	-	-
			RAA100 I+4 V2016	-	-

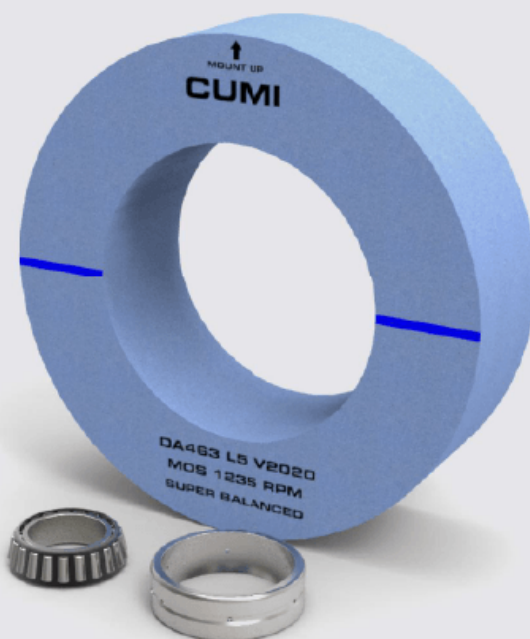

BEARING ROLLER

Type	Operation	Speed	Best	Better	Good
Outer Diameter - Taper Roller	Rough	35	65A801 L RT1	A80 L RT3	A80 L RT1
		50	65A801 L RT45	A80 L RT45	-
		35	-	A80 MRT3	-
		50	For >1.5" roller	5SBA60 K5 V50	-
	Finish	35	65A100 M RT1	A120 M RT1	A100 M RT1; A120 L RT1
			65A120 L RT1		
	50	For >1.5" roller		5SA80 K5 V50 DA80 J5 V2020/50	
		Fine Finish	35	DA400 H7 RBCX	-
50	DA500 H7 RBCX		-	-	
Outer Diameter - Cylindrical Rollers	Rough	35	1CUMISA60 J6 VCAE	53A60 J7 VC500	AA60 K5 V8
		50	1CUMISA60 J6 VC500/50	53A60 J7 VC500/50	AA60 K5 V50
	Finish	35	1CUMISA80 J6 VCAE	53A80 J7 VC500	AA80 K5 V8
		50	1CUMISA80 J6 VC500/50	53A80 J7 VC500/50	AA80 K5 V50
Needle Roller	Rough	35	GC120 M5 VG	-	-
		50	GC120 M5 VG/50	-	-
	Finish	35	GC1201 N5 VS2110M/50	A120 M RT1	A120 L RT1



PINS

Type	Operation	Speed	Best	Better	Good
Gudgeon Pin	Rough	35	1CUMISA461 K6 VCAE	AA463 L5 V2020	A463 L5 V10C
		50	1CUMISA461 K6 VC500/50	AA463 K5 V2020/50	A463 K5 V45C
	Semi Finish	35	1CUMISA601 K6 VCAE	AA60 L5 V2020	A60 L5 V10C
		50	1CUMISA601 K6 VC500/50	AA60 K5 V2020/50	A60 K5 V45C
	Finish	35	1CUMISA100 J6 VC500	AA100 J5 V2020	A100 J5 V10C
		50	1CUMISA100 J6 VC500/50	AA100 J5 V2020/50	A100 J5 V45C
	Fine Finish	35	-	A220 N5 VK12	-
	Super Finish	35	A400 F5 RABX	C320 P5 BYZ	-
		45	A400 G7 RBCX	-	-

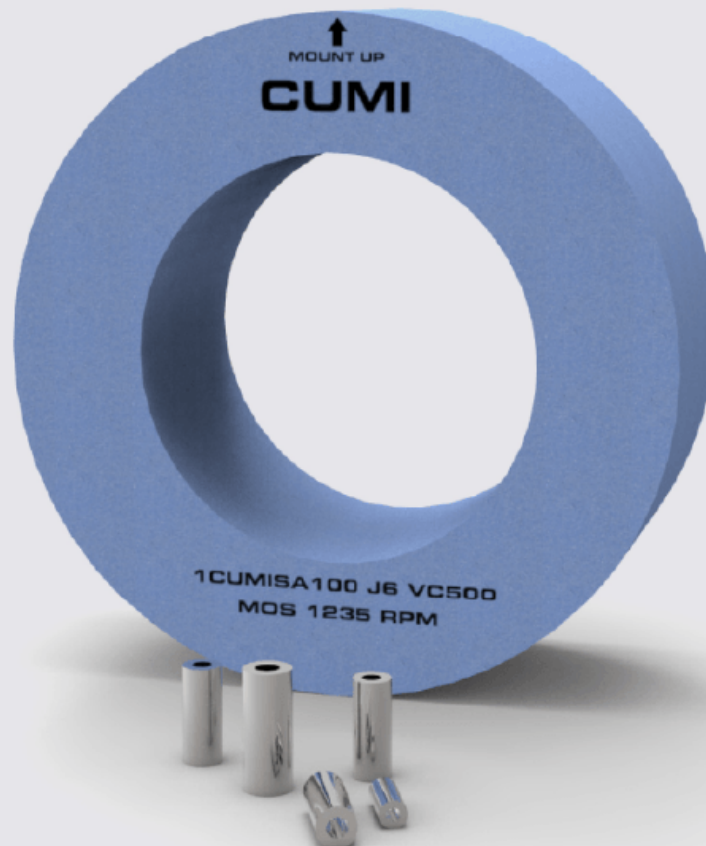

SHOCK ABSORBER

Type	Operation	Speed	Best	Better	Good
Inner Tube / Fork Pipe	Rough	35	55A603 N7 B99 55A603 J7 B600	DA603 N7 B99	A80 N7 B310
		50	55A603 N7 B99/50 55A603 J7 B600/50	DA603 N7 B99/50	A80 N7 B310/50 A220 L RT1
	Semi Finish	35	65A220 L RT1	DA220 L RT1	A220 L RT1/50
		50	65A220 L RT1/50	DA220 L RT1/50	-
	Finish	35	DA4002/A5005 H7 RBCZ/50	-	-
		50	-	-	-
Piston Rod	Rough	35	55A603 N7 B99 55A603 J7 B600	A801 N7 B99	A60 K5 V10C
		50	55A603 N7 B99/50 55A603 J7 B600/50	DA603 N7 B99/50	-
	Semi Finish	35	65A220 L RT1	A220 L RT1	-
		50	65A220 L RT1/50 DA120/DA240/A400 H7 RBCZ/50	A220 L RT1/50	-
	Finish	35	AA 400/A500 G5 RBCZ DA400 H7 RBCZ/50	-	-
		50	A500 H7 RBCZ/50	-	-



BRIGHT BAR

Type	Operation	Speed	Best	Better	Good
BRIGHT BAR	Rough	35	C463 M5 VG	C/G463 M5 VPZ	DA463 L5 V600
		50	1CUMISA463 N5 B820/50	CA60 J5 B99S/50	-
	Finish	35	-	C601 M5 VG	DA60 L5 V600
		50	1CUMISA603 N5 B820/50	C603 N5 B820/50 CA60 J5 B99S/50	

Aerospace

Type	Component Material	CUMI Recommend	Speed
FASTENERS	Hard steel	A80 N5 /A120 P5 V2018	33mps
	Titanium	GC120 R5 VFG	33mps
	Inconel	3CSA120 P7 VF920	33mps



PISTONS & LINERS

Type	Operation	Speed	Best	Better	Good
Piston Ring	Rough	35	-	-	C463 L5 VG
		50	-	-	-
	Finish	35	-	-	C60 L5 VG
		50	-	-	-

Type	Operation	Speed	Best	Better	Good
Grey Cast Iron	Rough	35	C543 J7 B190K	-	C543 K5 B190
		50	C543 J7 B190K/50	-	C543 K5 B190/50
SG Iron	Rough	35	-	C543 K5 B903	-
		50	-	C543 K5 B903/50	-



DRILLS & TAPS

Type	Operation	Speed	Best	Better	Good
Drills & Taps	Rough	35	5SBA463 M5 V10C	A463 L5 V446C	A463 L5 V10C
		50	5SBA463 M5 V50C	A463 L5 V446C/50	A463 L5 V50C
	Semi Finish	35	DA60 M5 V10C	A60 L5 V446C	A60 L5 V10C
		50	DA60 M5 V50C	A60 L5 V446C/50	A60 L5 V50C
	Finish	35	DA80 K5 V10C	A80 K5 V446C	A80 K5 V10C
		50	DA80 K5 V50C	A80 K5 V446C/50	A80 K5 V50C



FEED/REGULATING WHEELS

ABOUT FEED/REGULATING WHEELS

CUMI's regulating wheels are the best in class in the world. These wheels are made using a distinct calendaring process, leading to superlative & consistent performance making it as the most preferred product in the industry. The controlled wear not only leads to highly precise components but also gives longer life.

FEATURES:

- Tough grains for long life
- Resilient rubber for better finish

PRODUCT RECOMMENDATION

For Rough	A80 RR
For Size Control	A120 RR
	A 150 RR
For Size Control & Better Finish	A180 RR A180 TR



BONDED ABRASIVES CYLINDRICAL GRINDING WHEELS

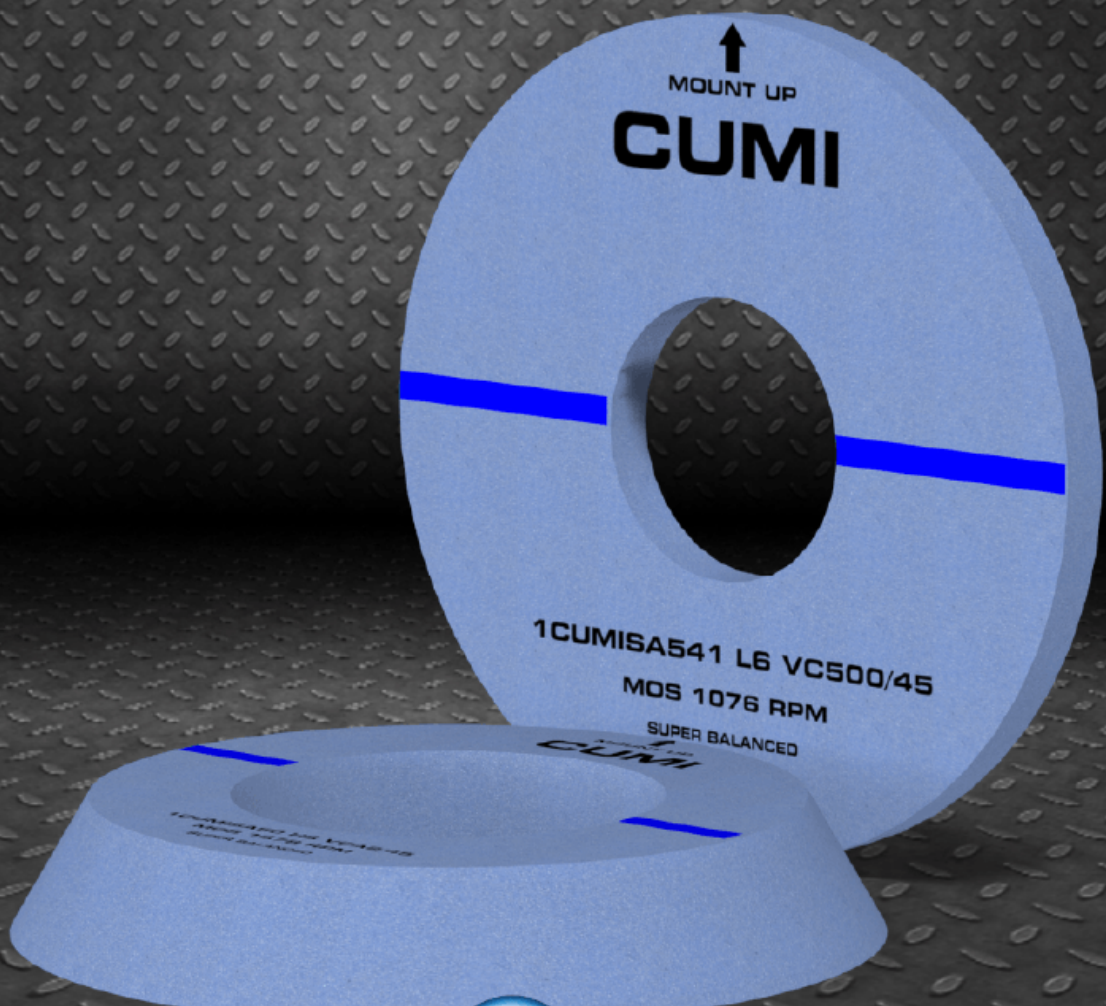

CYLINDRICAL GRINDING



BONDED ABRASIVES

CYLINDRICAL GRINDING WHEELS

ABOUT CYLINDRICAL GRINDING WHEELS

CUMI's versatile range of cylindrical wheels are used for a variety of grinding operations that require size generation, fine surface finish and fast stock removal. Special wheels are also available for multiple diameters and shoulder grinding with pre-formed wheel faces.

CUMI's cylindrical grinding wheels find wide application in the grinding of valves, plunger pins, eye bolts, transmission shafts, cam shafts, crank shafts etc.,

FEATURES:

- Best choice of abrasive grain wheels for higher stock removal, higher productivity and form retention
- Customizes sketches for every customer requirement
- Wide range of bond system to customize individual grinding needs



CYLINDRICAL GRINDING WHEELS

ADVANTAGES OF CUMI WHEELS

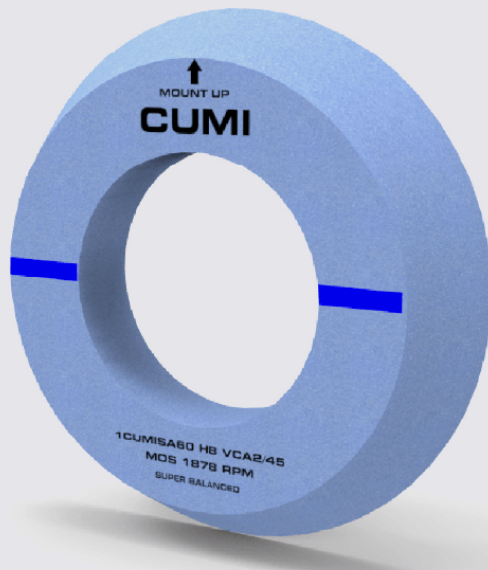

1. High stock removal
2. Better productivity
3. Excellent surface finish
4. Lower dressing frequency
5. Burn free component

CUMI Code	Grit Range	Diameter		Thickness		Hardness	Structure	Speed
		mm	inch	mm	inch			mps
CN	46 - 120	300 - 600	12 - 26	25-150	1 - 6	H - M	6 - 13	35, 50 & 63
CUMISA/CSA				25 - 150	1 - 6	H - M	6 - 13	35, 50 & 63
SBA				25 - 250	1 - 10	H - M	5 - 8	35 & 50
50A				25 - 150	1 - 6	H - M	6 - 13	35 & 50
RA				25 - 150	1 - 6	H - M	5 - 8	35 & 50
5SA				25 - 150	1 - 6	H - M	5 - 8	35, 50 & 63
AA				25 - 250	1 - 10	H - M	5 - 8	35, 50 & 63
DA				25 - 150	1 - 6	H - M	5 - 8	35 & 50
A				25 - 150	1 - 6	H - M	5 - 8	35 & 50
CGC				25 - 150	1 - 6	H - M	5 - 8	35 & 50
GC				25 - 150	1 - 6	H - M	5 - 8	35 & 50
C				25 - 150	1 - 6	H - M	5 - 8	35 & 50

SHAPES



COMMONLY USED MACHINES

- Schaudt • Landls • Paragon • Palmary • Studer
- Junker • NTC • Micromatic • T-Sugami • Shigya • Okamoto • Okuma

CYLINDRICAL GRINDING WHEELS

HIGH SPEED STEEL

Hardness	Speed	Best	Better	Good
Low content Vanadium & Molybdenum	35	1CUMISA60 J6 VC500	RAA60 J5 VF8	AA60 K5 V8
	50	1CN60 J6 VC500/50	RAA60 J5 VF8/50	AA60 K5 V50
High content Vanadium & Molybdenum	35	1CUMISA601 H12 VCA2	RAA601 H10 V736	AA601 H10 V736
	50	1CN601 G12 VCA2/50	RAA601 G10 V736/50	AA601 G10 V736/50

TUNGSTEN CARBIDE

Hardness	Speed	Best	Better	Good
For all HRc	35	GC60 K5 VG	CGC60 K5 VG	C60 K5 VG
	50	GC60 J5 VS2110/50	CGC60 J5 VS2110/50	C60 J5 VS2110/50

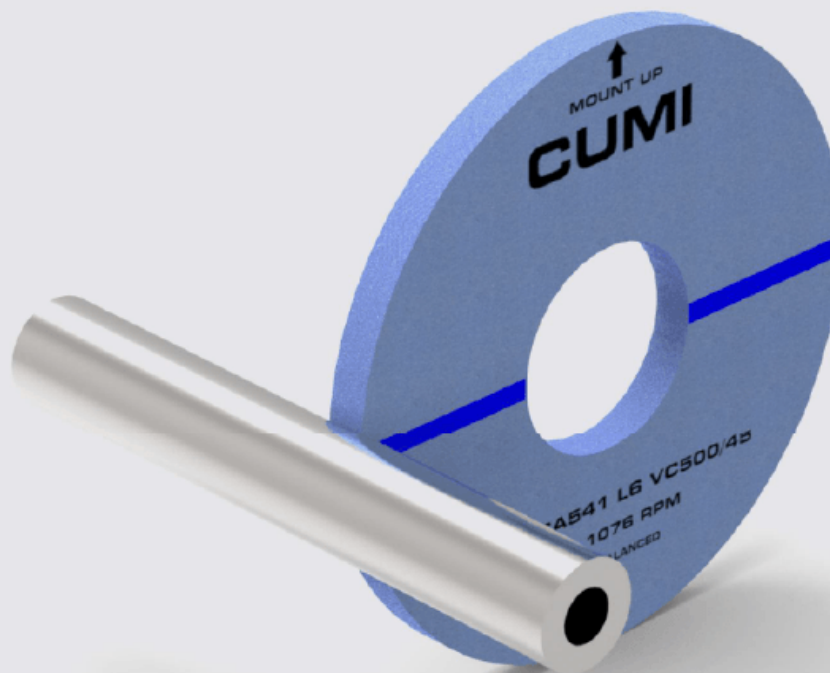

CYLINDRICAL GRINDING WHEELS

GENERAL PURPOSE

Hardness	Speed	Best	Better	Good
< 40 HRc	35	AA463 M5 V2016	DA463 M5 V10	A463 M5 V10
	50	1CUMISA541 L6 VC500/50	5SA463 L5 V500/50	DA463 M5 V50
	63	1CUMISA541 L6 VC500/60	AA463 L5 V60	5SA463 L5 V500/60
50 HRc to 60 HRc	35	AA463 K5 V2016	DA463 K5 V10	A463 K5 V10
	50	1CUMISA541 J6 VC500/50	5SA463 J5 V500/50	DA463 K5 V50
	63	1CN541 J6 VC500/60	AA463 J5 V60	5SA463 J5 V500/60

CAST IRON

Hardness	Speed	Best	Better	Good
< 40 HRc	35	GC463 N5 VG	-	-
	50	GC463 N5 VS2110/50	-	-
	63	-	-	-
50 HRc to 60 HRc	35	GC463 L5 VG	-	-
	50	GC463 L5 VS2110/50	-	-
	63	-	-	-

STEEL

Hardness	Speed	Best	Better	Good
< 40 HRc	35	AA463 M5 V2016	SBA463 M5 V10	A463 M5 V10
	50	1CUMISA541 K6 VC600/50	5SA463 L5 V500/50	DA463 M5 V50
	63	1CUMISA541 K6 VC600/60	5SA463 L5 V500/60	AA463 L5 V60
50 HRc to 60 HRc	35	53MA541 J7 VC500/50	5SA463 K5 V500	AA46/54 K5 V8
	50	53MA541 J7 VC500/50 1CUMISA541 J6 VC600/50	5SA463 K5 V500/50 5SA463 J5 V500/60	AA46/54 K5 V50 AA54 J5 V60
	63	53MA541 J7 VC500/60 1CN541 J6 VC600/60		

STAINLESS STEEL 300 SERIES

Operation	Speed	Best	Better	Good
Rough	35	GC463 K5 VG	CGC463 K5 VG	AC463 K5 VG
Finish		GC80 J5 VG	CGC80 J5 VG	C80 J5 VG
Rough	50	GC463 K5 VS2110/50	CGC463 K5 VS2110/50	C463 K5 VS2110/50
Finish		GC80 J5 VS2110/50	CGC80 J5 VS2110/50	C80 J5 VS2110/50
	Upto 35		GC60 J11 VR	
Rough	35	1CUMISA461 J6 VC500	RAA46/54 J5 VF8	AA46/54 K5 V8
Finish		1CUMISA801 J6 VC500	RAA80 J5 VF8	AA80 J5 V8
Rough	50	1CUMISA461 J6 VC500/50	RAA46/54 J5 VF8/50	AA46/54 K5 V50
Finish		1CUMISA801 J6 VC500/50	RAA80 J5 VF8/50	AA80 J5 V50
	Upto 50 MPS	1CUMISA461 H12 V736/50	RAA461 H10 V736/50	AA461 H10 V736/50

CYLINDRICAL GRINDING WHEELS

SOFT STEEL (< 40 HRC)

Operation	Speed	Area of Contact	Best	Better	Good
Rough	35	<= 10 mm	AA46/54 L5 V8	DA 463 K5 V10	A463 K5 V10
	50		AA46/54 L5 V50	DA 463 K5 V50	A463 K5 V50
	35	> 10 mm	AA46/54 J7 V8	DA463 J7 V10	A463 J7 V10
	50		AA46/54 J7 V50	DA463 J7 V50	A463 J7 V50
Finish	35	<= 10 mm	AA60 K5 V8	DA60 K5 V10	A60 K5 V10
	50		AA60 K5 V50	DA60 K5 V50	A60 K5 V50
	35	> 10 mm	AA60 I7 V8	DA60 I7 V10	A60 I7 V10
	50		AA60 I7 V50	DA60 I7 V50	A60 I7 V50

HARD STEEL (> 40 HRC)

Operation	Speed	Area of Contact	Best	Better	Good
Rough	35	<= 10 mm	1CUMISA60 H8 V736	53A60 H8 VCA2 RA60 K5 VF8	AA60 H8 V736
	50		1CN60 H8 V736/50	53A60 H8 VCA2/50 RA60 J5 VF8/50	AA60 H8 V736/50
	35	> 10 mm	1CUMISA60 H10 V736	53A60 H10 VCA2 RA60 K5 VF8	AA60 H10 V736
	50		1CN60 H12 V736/50	53A60 H12 VCA2/50 RA60 J5 VF8/50	AA60 H12 V736/50
Finish	35	<= 10 mm	1CUMISA80 H8 V736	53A80 H8 VCA2 RA80 K5 VF8	AA80 H8 V736
	50		1CN80 H10 V736/50	53A80 H10 VCA2/50 RA80 J5 VF88/50	AA80 H10 V736/50
	35	> 10 mm	1CUMISA80 H12 V736	53A80 H12 VCA2 RA80 K5 VF8	AA80 H12 V736
	50		1CN80 H13 V736/50	53A80 H13 VCA2/50 RA80 J5 VF8/50	AA80 H13 V736/50

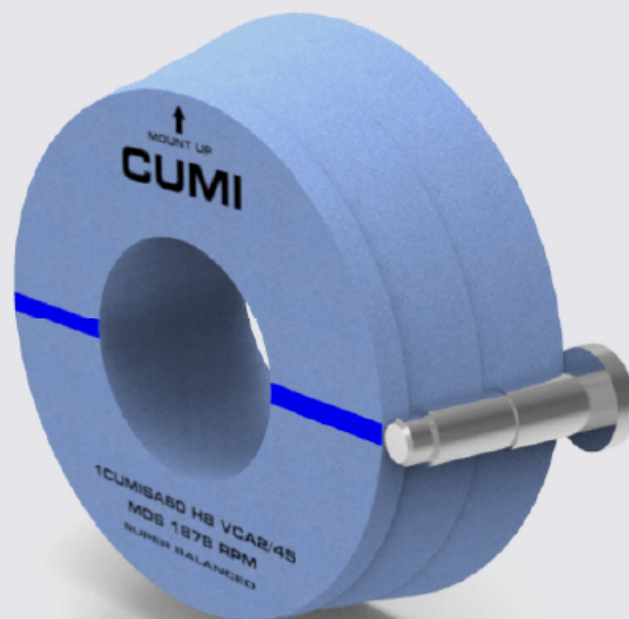

BONDED ABRASIVES

CRANKSHAFT GRINDING WHEELS



CRANKSHAFT GRINDING WHEELS

ABOUT CRANKSHAFT GRINDING WHEELS

What sets Crankshaft grinding apart from the other cylindrical grinding process is the extremely crucial function of the crankshaft in itself. Crankshaft design requires meticulous attention from material selection to the various hardening processes. Each part of the crankshaft is designed to have different hardness meeting specific demands of the application. Grinding of the shoulder region is a surface grinding operation, while the grinding of the pin is a cylindrical grinding operation. This poses a great challenge in designing a wheel that performs both these processes efficiently.

With the incorporation of the latest advances in Abrasive grains and Vitrified bond technology, CUMI provides Crankshaft grinding wheels that can face each of these challenges. The basic composition of the wheels are designed to give maximum life and excellent form holding while physical forms like slotted wheels, sandwich wheels, dual grade wheels etc. enable the wheels to grind without burns.

FEATURES:

- Sharp & friable aluminium oxide grains
- Low temperature fired fusible vitrified bond system
- Uniform density and hardness across wheel diameter
- Perfectly balanced
- Sandwich option for higher feed rates & improved form holding



CRANKSHAFT GRINDING WHEELS

ADVANTAGES OF CUMI WHEELS



1. Lower BV (Barkhausenvalue)
2. Lower dressing depth
3. No surface cracks
4. Lower cost per component
5. Good form retention
(for better radius profile)

WIDTH OF PRODUCT RANGE

CUMI Code	Grit	Diameter		Thickness		Speed	Hardness	Structure
		mm	inch	mm	inch			
11RA/51RA	46 - 100	600 - 1200	24 - 48	19 - 125	3/4 - 5	upto 60	J - M	5 - 8
12A								
AA								
DA								
A								

SHAPES

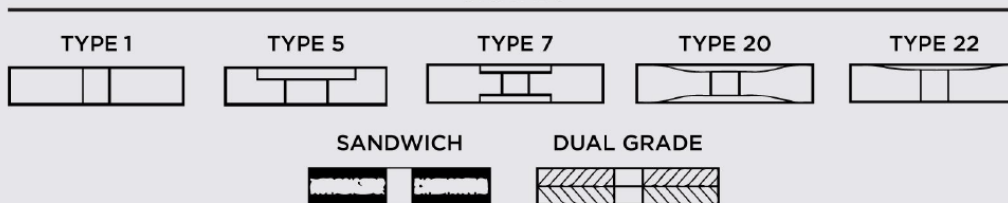

AUTO COMPONENTS

COMMONLY USED MACHINES

• Cincinnati • NTC • Landis • Tos • Churchill Naxos Union • Norton • Junker

Type	Operation	Speed	Best	Better	Good
Forged Steel	Soft	35	12A54/60 J7 V2020	AA463 K5 V2020	A463 L5 V10X
		50	12A54/60 I7 V2020/50	AA463 K5 V2020/50	A463 K5 V50X
		60	11RA54/60 J7 V2020/60	12A467 I7 V2020/60	AA463 K5 V2020/60
	Hard - PV	35	12A601 K5 V2020	SA601 K5 V2020	A601 K5 V10X
		50	12A601 K5 V2020/50	AA601 K5 V2020/50	DA601 K5 V2020/50
		60	11RA54/60 J7 V2020/60	12A601 K5 V2020/60	SA601 K5 V2020/60
	Hard - CV	35	12A467 J7 V2020	AA463 K5 V2020	A463 L5 V10X
		50	12A467 I7 V2020/50	AA463 K5 V2020/50	A463 K5 V50X
		60	11RA54/60 J7 V2020/60	12A467 I7 V2020/60	AA463 K5 V2020/60
	For Soft shoulder & Hard Center Grinding	60	2CUMISA542 J+6 V500/60 (sides) / AA602 J6 V500/60(Center)	5SA543 K5 V500/60	DA543 K5 V500/60 (sides)
5SA601 K5 V500/60				DA601 K5 V500/60 (center)	
Cast Iron		upto 50	AA46 K5 V2020/50	SA46 K5 V2018/50	DA46 K5 V50
Nodular Iron		upto 50	1CUMISA461 K6 V2020/50	5SA46 L5 V2020/50	AA46 L5 V2020/50



CRANKSHAFT GRINDING



BONDED ABRASIVES

BONDED ABRASIVES

CAMSHAFT GRINDING WHEELS

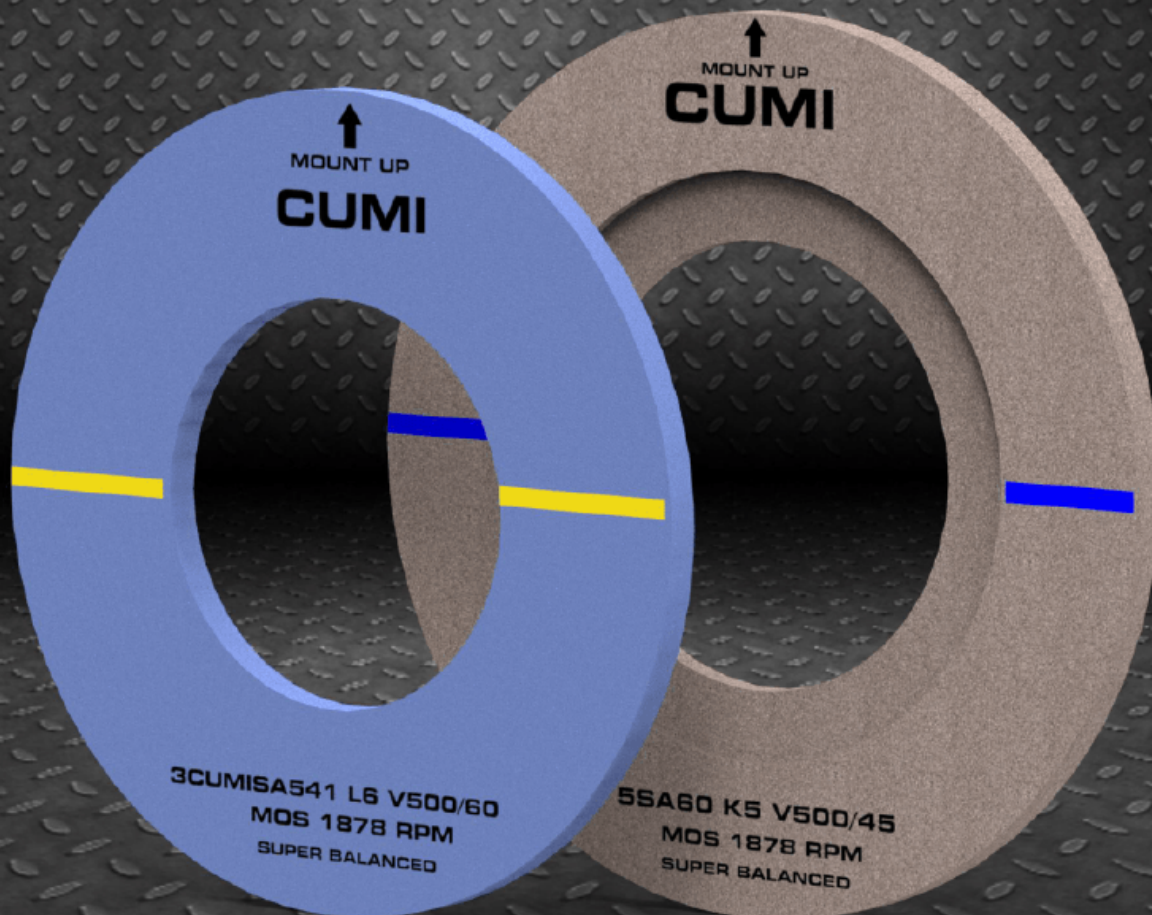

CAMSHAFT GRINDING



BONDED ABRASIVES

CAMSHAFT GRINDING WHEELS

ABOUT CAMSHAFT GRINDING WHEELS

CUMI'S Camshaft wheels offer good form holding, free cutting ability while maintaining the stringent geometrical and surface finish requirement to maintain consistent and tight surface finish tolerances. CUMI's versatile camshaft wheels can grind materials like forged steel and chilled cast iron with highest amount of stock removal without thermal damage on the cam flank.

CUMI also offers single wheel for both roughing and finishing operations

FEATURES:

- Sharp & friable Aluminium Oxide grains
- Vitrified Krystal bond system(V500)
- Uniform density and hardness across wheel diameter
- Perfectly balanced

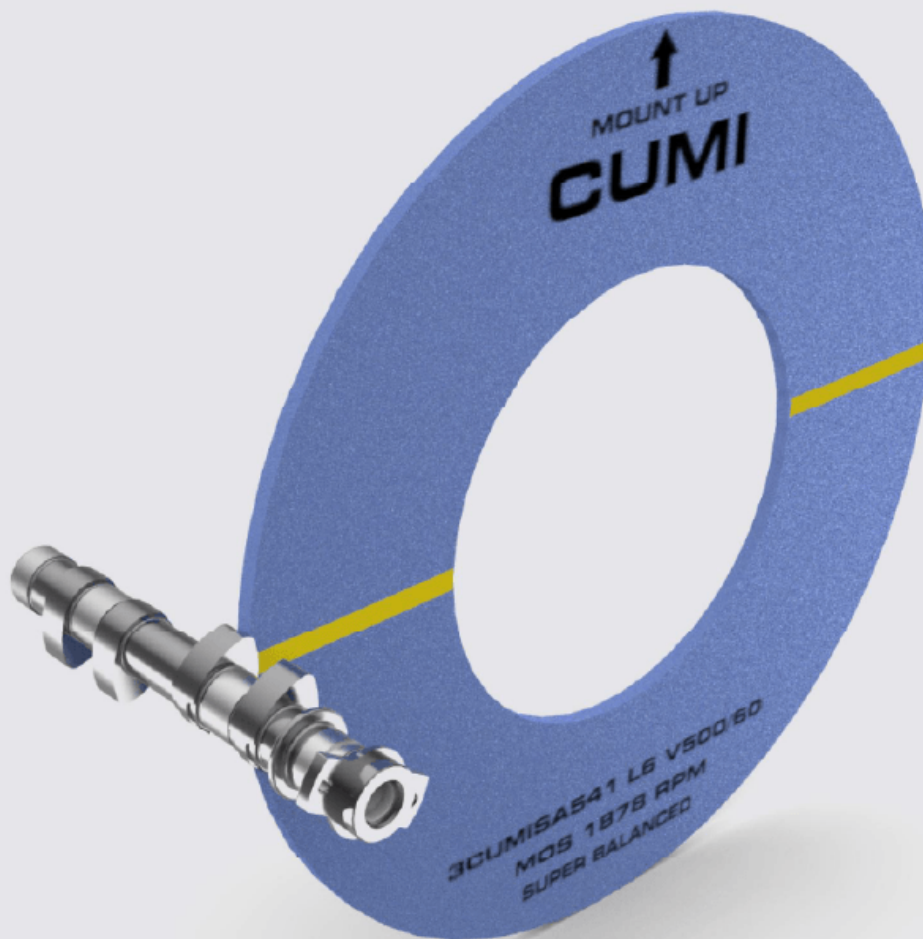

CAMSHAFT GRINDING WHEELS

ADVANTAGES OF CUMI WHEELS



1. High productivity
2. Excellent form retention
3. Dimensional accuracy
4. Surface finish
5. Form accuracy

WIDTH OF PRODUCT RANGE

CUMI Code	Grit Range	Diameter		Thickness		Speed	Hardness	Structure
		mm	inch	mm	inch	mps		
CUMISA/CN	54 - 80	500 - 610	20 - 24	25 - 40	1 - 1 1/2	60	J - M	5 - 8
SA								
AA								

SHAPES



AUTO COMPONENTS

COMMONLY USED MACHINES

- Landis
- Naxos Union
- NTC



Type	Operation	Speed	Best	Better	Good
Case Hardened Steel	Rough	upto 60	1CUMISA541 K6 VC500/60	5SA54 K5 V500/60	AA54 K5 V60
	Finish		1CUMISA801 J6 VC500/60	5SA80 J5 V500/60	AA80 I5 V60
	Rough & Finish		3CUMISA80 R20 BH99/60	1CUMISA80 R20 BH99/60	1CUMISA542 L6VC500/60
Nodular Iron	Rough	upto 60	3CUMISA461 L6 V500/60	5SA463 L5 V500/60	AA463 L5 V2020/60
	Finish		3CUMISA801 J6 VC500/60	5SA80 J5 V500/60	AA80 I5 V60
Chilled Cast Iron	For Base Circle Diameter <= 25mm	upto 60	3CUMISA80 R20 BH99/60	5SA80 L5 V500/60	AA80 L5 V2020/60
	For Base Circle Diameter > 25mm		3CUMISA80 R23 BH99/60	5SA801 J5 V500/60	AA801 J5 V2020/60

AUTO COMPONENTS



CAM JOURNAL

Type	Operation	Speed	Best	Better	Good
Case Hardened Steel	All Operations	upto 50	1CUMISA801 J6 VC500/50	5SA60 K5 V500/50	AA601 K5 V50
Nodular Iron	Rough & Finish	upto 50	1CUMISA80 K6 VC500/45	5SA801 K5 V500/50	AA80 L5 V50



BONDED ABRASIVES F TYPE GRINDING WHEELS



F TYPE GRINDING



BONDED ABRASIVES

F TYPE GRINDING WHEELS

ABOUT F TYPE GRINDING WHEELS (DOUBLE DISC)

F type wheels or Fastening type wheels are resinoid wheels which are fastened to the back plates using bolts. The face of the wheel is used to grind components and generate flat and parallel surfaces. Used in various industries like Bearings, Auto etc. The applications usually demand high stock removal along with tight size tolerances and fine surface finishes. Since the area of grinding is very large, heat generation is high, provisions are made in the chemical and physical design of the wheel to ensure that there is enough scope for heat dissipation by effective utilization of coolants.

CUMI wheels are proven to perform at high feed rates and material removal applications while meeting stringent quality requirements in terms of size tolerances, heat generation and surface finishes, thanks to the special technology of grain-bond combination, which ensures free cutting. Physical features like coolant slots, through holes and honeycomb structure aid in taking the performance of the wheels to the next level.

FEATURES:

- Wide range of bonds including phenolic and Epoxy
- Huge variety of high performance products using Aluminium oxide, Silicon carbide, micro-crystalline and mono crystalline grains
- Engineered design modifications comprising honey comb, slots

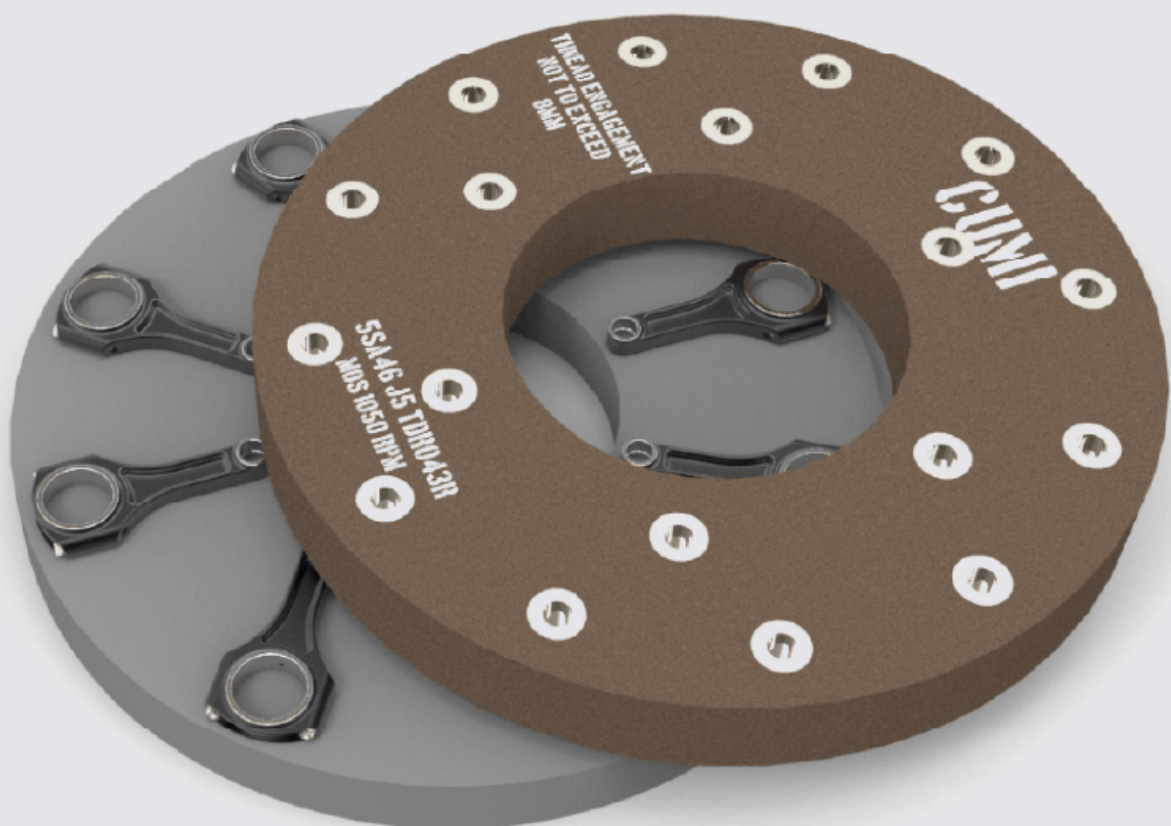

F TYPE GRINDING WHEELS

ADVANTAGES OF CUMI WHEELS

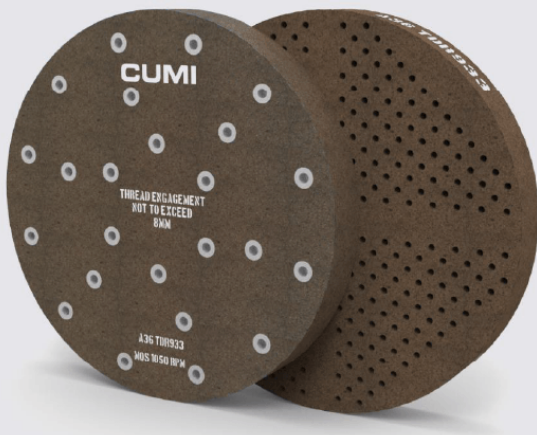

1. Free cutting action
2. Less dressing intervention
3. Good surface finish
4. Excellent feed rate
5. Excellent part geometry

WIDTH OF PRODUCT RANGE

CUMI Code	Grit Range	Diameter		Thickness		Speed mps	Hardness	Structure
		mm	inch	mm	inch			
CUMISA /CSA	16 - 150	150 - 1000	6 - 40	50 - 120	2 - 5	33	G - O	5 - 10
50A	24-220							
DA	24 - 220							
AA	20 - 500							
GC	24 - 500							
C	24 - 500							
A	24 - 600							

AUTO COMPONENTS



CONNECTING ROD



PISTON RING

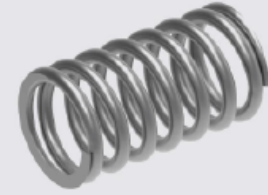

SPRING

CONNECTING ROD

Type	Operation	Speed	Best	Better	Good
Forged steel	Rough	33	58AA46 J7 BR9	52AA46 J7 BR9	-
	Finish		58AA60 J7 BR9	52AA60 J7 BR9	-
Sintered	Rough	33	58AA46 J5 BR9	52AA46 J5 BR9	-
	Finish		58AA60 J5 BR9	52AA60 J5 BR9	-

PISTON RING

Type	Operation	Speed	Best	Better	Good
Cast Iron	Rough	33	-	C46 J7 B10CS	CGC46/60 J5 TD1020M
	Semi Finish		1CE/C80 I5 B1286	C801 J5 B10CS	CGC80 J5 TD1020
	Finish		1CE/C120 K5 B1241	GC/RA120 H5 TDR845	GC120 TDR659
	Lapping		1CE/C1201 I+5 BRT	-	C150 J5 BRT

SPRING

Type	Operation	Speed	Best	Better	Good
Cast Iron	Rough	33	2CUMISA24 N7 B266	AA20 L7 TDV819M & A24 N7 B266	A24 L7 TDR085
	Finish		2CUMISA30 O7 B266	54AA30 N7 B266	DA30 N7 B266
	Rough & Finish - Single Head		2CUMISA24 N7 B266	A36 TDR933	DA24 TDR699

AUTO COMPONENTS

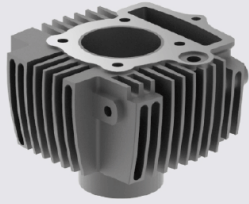

ENGINE BLOCK

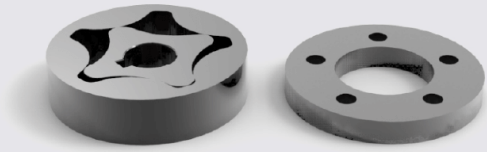

SINTERED COMPONENT

ENGINE BLOCK

Type	Operation	Speed	Best	Better	Good
Cast Iron (For Passenger Car)	Rough - Rotary Table	33	-	C24 L5 SPL	C24 K5 BRT
	Finish - Rotary Table		-	C80 L6 SPL	C120 K5 BRT
Cast Iron (For Heavy Commercial Vehicle)	Rough & Finish		-	C16 TDR1358/ C24 TDR1399	C14 TDR312

SINTERED COMPONENT

Type	Operation	Speed	Best	Better	Good
Sintered	Rough	33	-	-	GC46 B056
	Finish		-	-	GC80 B056



BEARING INDUSTRY

PRODUCT RECOMMENDATION



BALL BEARING RING



TAPER ROLLER RING

BALL BEARING RING

Type	Operation	Best	Better	Good
Bearing Steel	Rough & finish	55A80 N7 BRT	D80 N7 BRT	A80 N7 BRT A80 M5 B14F

TAPER ROLLER BEARING RING

Type	Operation	Best	Better	Good
Bearing Steel	Big Face	53A46 G7 BRT	–	DA46 G7 BRT
	Small Face	53A60 M5 BRT	–	AA60 L5 BRT

TAPER ROLLER

Type	Operation	Best	Better	Good
Bearing Steel	Face Grinding	–	–	AA280 P19 BCC

BEARING INDUSTRY

CYLLINDRICAL/ SPHERICAL ROLLER

Type	Operation	Best	Better	Good
Bearing Steel	soft stage	–	–	A60 O5 BRT
	Hard stage		5SA80 L5 B14F AA100 M5 BRT	AA80 K5 BRT



BONDED ABRASIVES BORE GRINDING WHEELS

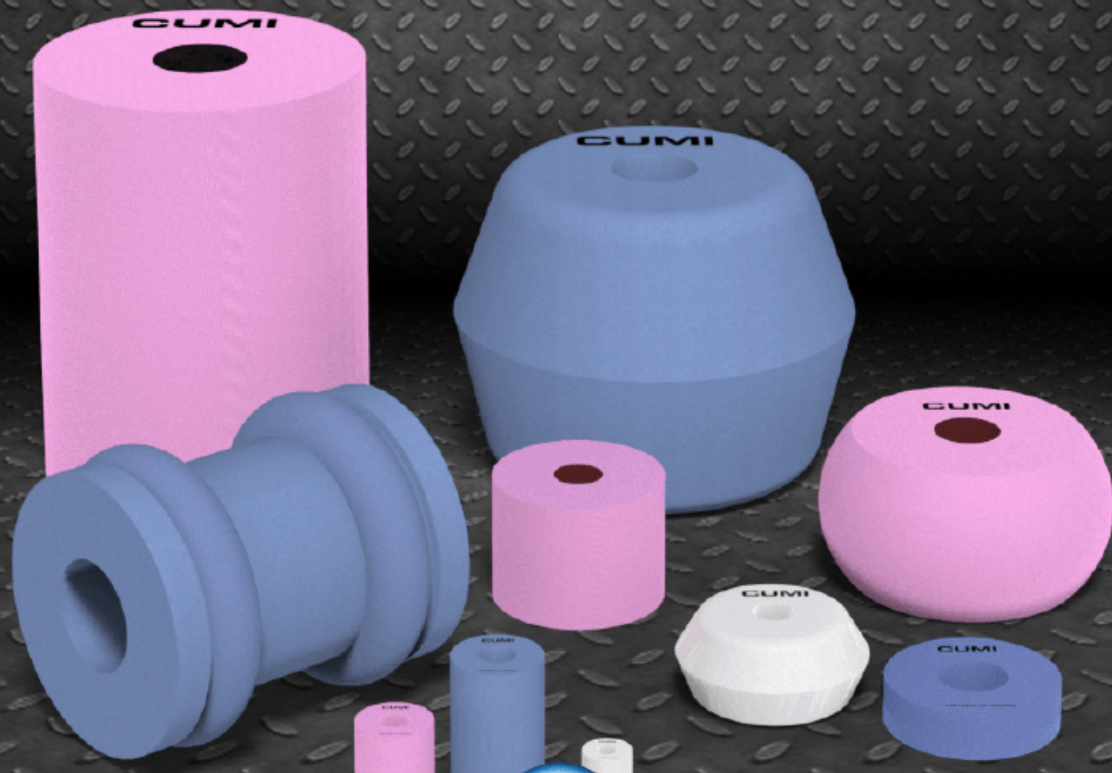

BORE GRINDING



BONDED ABRASIVES

BORE GRINDING WHEELS

ABOUT BORE GRINDING WHEELS

Internal or Bore Grinding wheels are used for grinding inner diameter of bearing, gears & automobile components to an accurate size & desired finish.

CUMI's versatile range of bore grinding wheels are used for grinding a variety of components that require size generation, fine surface finish and fast stock removal. We also offer value added services like Special treatment for lubrication & cooler cutting action.

FEATURES:

- Sharp aluminium oxide grains for excellent cutting action
- Krystal bond for form holding(V500)
- Available in various shapes

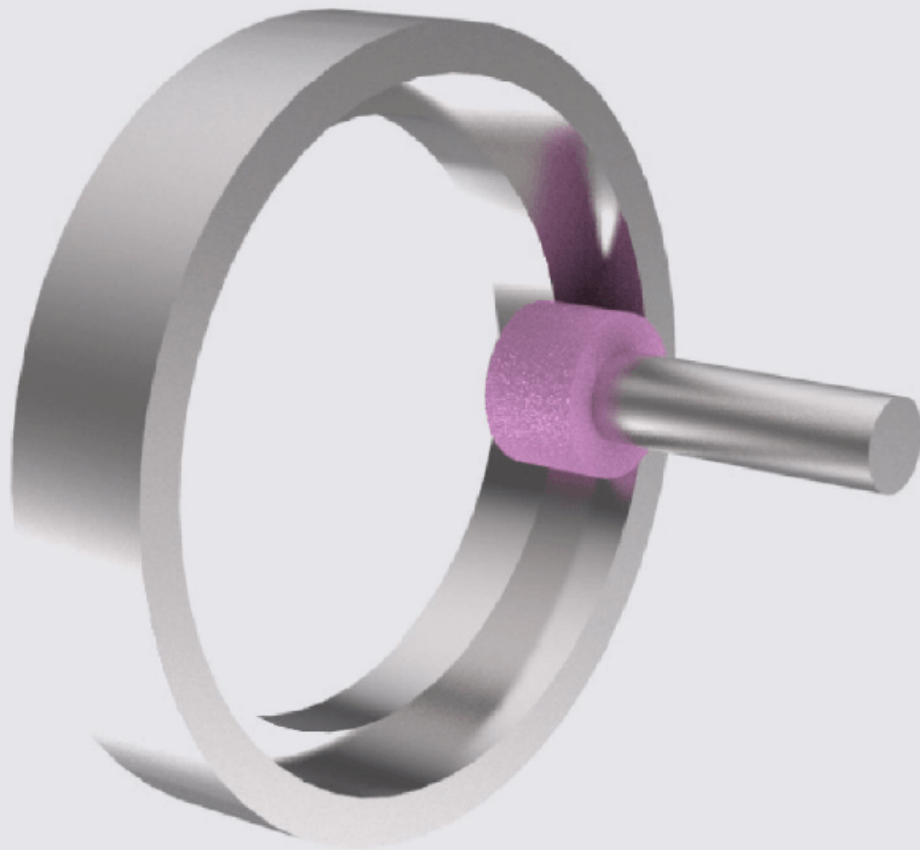

BORE GRINDING WHEELS

ADVANTAGES OF CUMI WHEELS



1. Good form retention
2. Excellent surface finish
3. Less dressing intervention
4. Reduced cycle time
5. Burn free surface

WIDTH OF PRODUCT RANGE

CUMI Code	Grit Range	Diameter		Thickness		Hardness	Structure	Speed
		mm	inch	mm	inch			mps
CN/CSA	60 - 120	10 - 20	3/8 - 5	5 - 75	1/5 - 3	I - M	6 - 8	33, 50 & 63
RA							7	
55A							7	
SA							5 - 8	

BEARING INDUSTRY

Material	Hardness	Bearing I.D (mm)	Speed	Best	Better	Good
Taper Roller Bearing (TRB)	55 - 60 HRc	≤ 70	upto 50	3CN80 J6 VC500	55A80 J7 VC500	SA60 J7 V144
			63	3CN80 J6 VC500	55A80 J7 VC500	RA60 J7 VF8
		> 70	upto 50	3CN80 I6 VC500	55A80 J7 VC500	SA80 J7 V144
			63	3CN80 I6 VC500	55A80 J7 VC500	RA80 J7 VF8

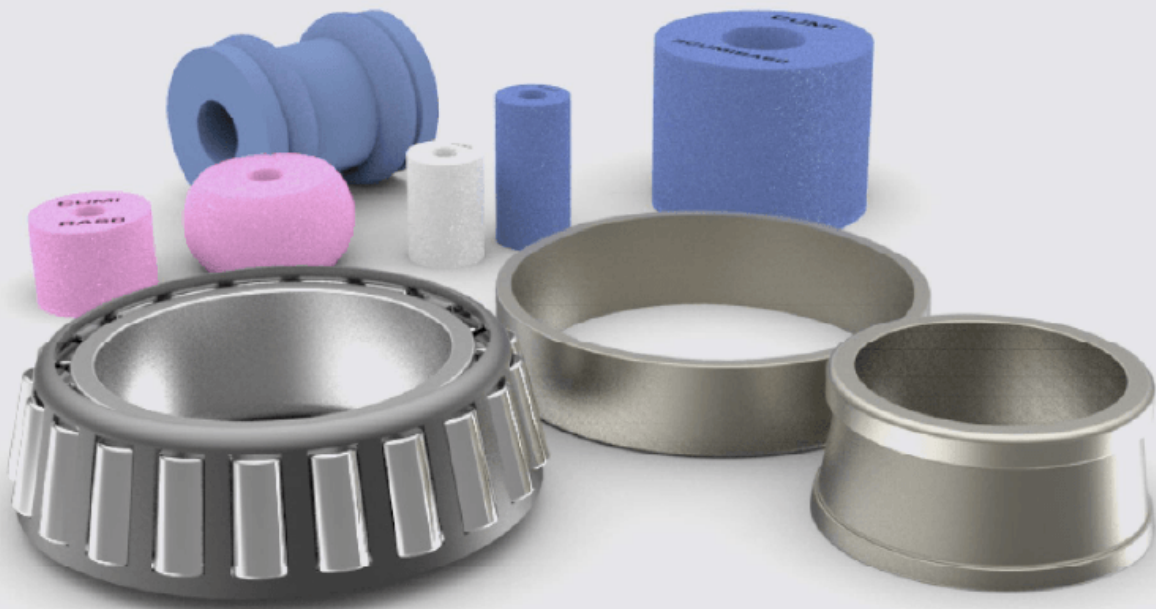

BONDED ABRASIVES IR TRACK GRINDING WHEELS

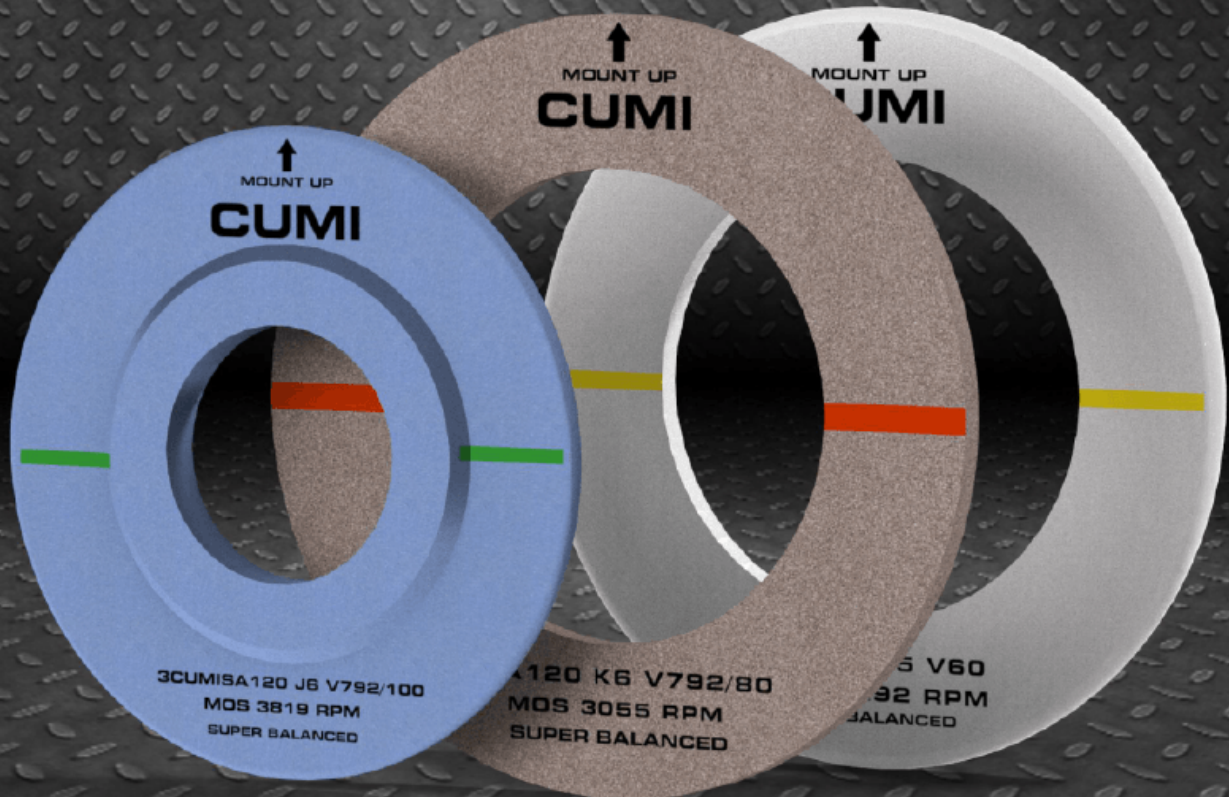

3CUMISA120 J6 V792/100
MOS 3819 RPM
SUPER BALANCED

A120 K6 V792/80
MOS 3055 RPM
SUPER BALANCED

5 V60
92 RPM
BALANCED

IR TRACK GRINDING



BONDED ABRASIVES

IR TRACK GRINDING WHEELS

ABOUT IR TRACKING WHEELS

With all the latest advancements in the field of automobiles and machine manufacturers, the functions of bearings are now more crucial than ever before, thereby placing greater demands on quality of bearings.

Track grinding wheels must maintain form to ensure profile accuracy of the track of inner ring. This ensures that the wheels are dressed less often, leading to significant improvement in productivity and consistency of the process.

CUMI's Track grinding wheels are made with a special fusible glassy bond with sharp abrasive grain combination that ensures form holding while offering high material removal rates in a high contact area application. An advanced manufacturing process ensures that the wheel's hardness is consistent through the wheel life and highest levels of safety are maintained.

FEATURES:

- Sharp crystal aluminium oxide grains
- Krystal bond for form holding & Safety
- Customized profiling as per requirement

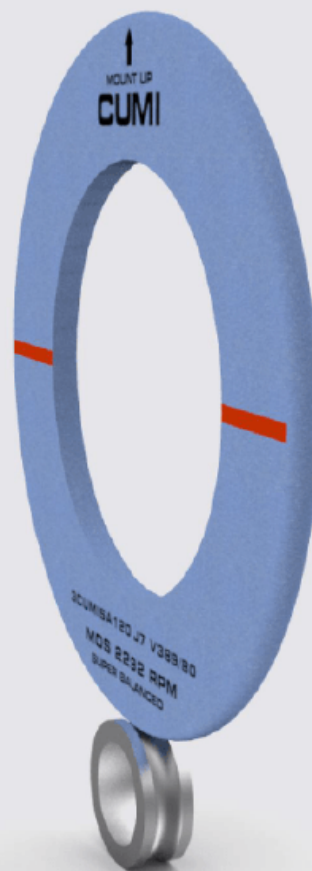

IR TRACK GRINDING WHEELS

ADVANTAGES OF CUMI WHEELS

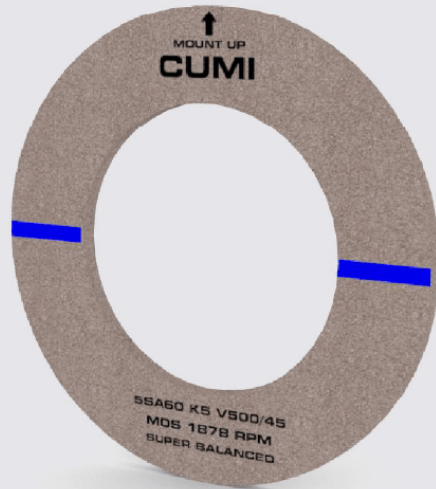

1. Profile holding & form retention
2. Less dressing intervention
3. Burn free component
4. Surface finish (0.3-0.4 Ra)
5. Roundness (<math><5Q</math>)

WIDTH OF PRODUCT RANGE

CUMI Code	Grit Range	Diameter		Thickness		Speed mps	Hardness	Structure
		mm	inch	mm	inch			
CN	80 - 150	350 - 610	14 - 24	10 - 40	3/8 - 11/2	33, 50, 63, 80, 100	I - L	5 - 7
50A								
CUMISA/CSA								
AA								

BEARING INDUSTRY



BALL BEARING RING



TAPER ROLLER RING

PRODUCT RECOMMENDATION

Bearing Type	Bearing Size	Speed	Best	Better	Good
Taper Roller Bearing (TRB)	up to 50mm	35	55A120 K7 VC500	12A120 K5 VCOOL	DA120 L7 V1092
		50	55A120 K7 VC500/50	-	DA120 K7 V1092/50
		63	-	-	AA120 K5 V60
		80	3CUMISA120 J7 V389/80	-	5SA120 K6 V792/80
		100	3CUMISA120 J6 V792/100	-	5SA120 K6 V792/100
	Above 50mm	35	AA100 L5 VF8	-	A100 L7 V1092
		50	55A100 K7 VC500/50	-	DA100 K7 V1092/50
		63	3CUMISA100 K7 V389/60	-	AA100 K5 V60
		80	3CUMISA100 J7 V389/80	-	5SA100 J6 V792/100
		100	3CUMISA100 J6 V792/100	-	5SA100 J6 V792/100
Ball Bearing	All	35	55A120 L7 VC500	-	DA120 L7 V1092
		50	55A120 K7 VC500/50	-	DA120 K7 V1092/50
		63	2CN1001 J6 V308C/60 3CSA1001 J6 V308C/60	-	AA100 K5 V60
		80	2CN1001 I6 V308C/80	-	5SA1001 J7 VC500/80
		100	3CUMISA120 J6 V792/100	-	5SA120 K6 V792/100



BONDED ABRASIVES THREAD GRINDING WHEELS

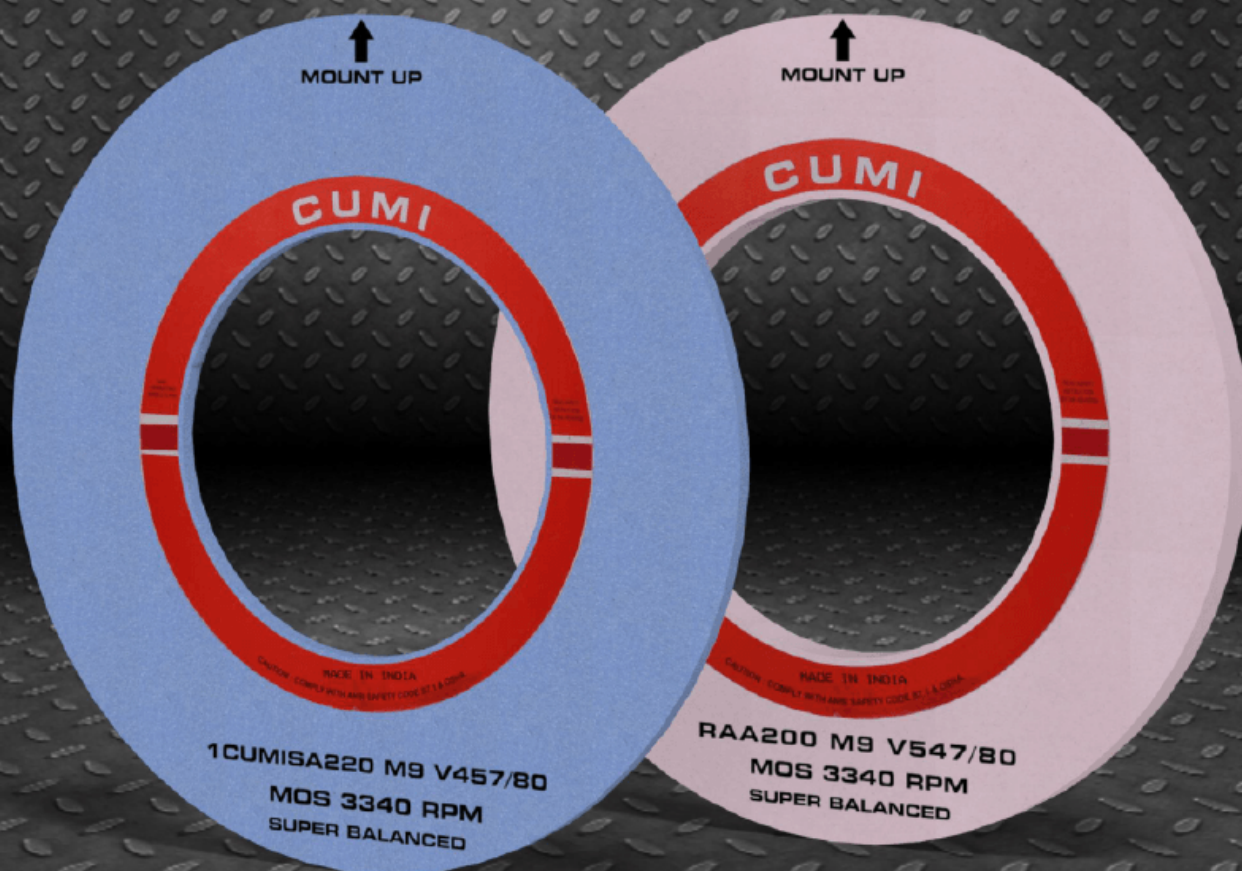

THREAD GRINDING



BONDED ABRASIVES

THREAD GRINDING WHEELS

ABOUT THREAD GRINDING WHEELS

Being a high speed, high material removal application with stringent demands on the thread profile, generating threads on taps and drills by grinding isn't an easy job.

CUMI's Thread grinding wheels are formulated with high purity, Sharp Aluminium Oxide grains combined with a special glassy, fusible bond. This ensures excellent form retention of the wheel, which translates into consistent thread profile of components.

FEATURES OF THREAD GRINDING WHEELS

- Hi performance hard, sharp & friable Aluminium Oxide abrasive blend
- Fusible, glassy crystalline bond for improved form holding
- Special manufacturing process for uniform hardness across diameter

FEATURES OF THREAD ROLL DIE GRINDING WHEELS

- High purity closely graded Green Silicon Carbide micro grits
- Special Low temperature fired Vitrified bond for improved form holding
- Special manufacturing process for uniform hardness across wheel thickness

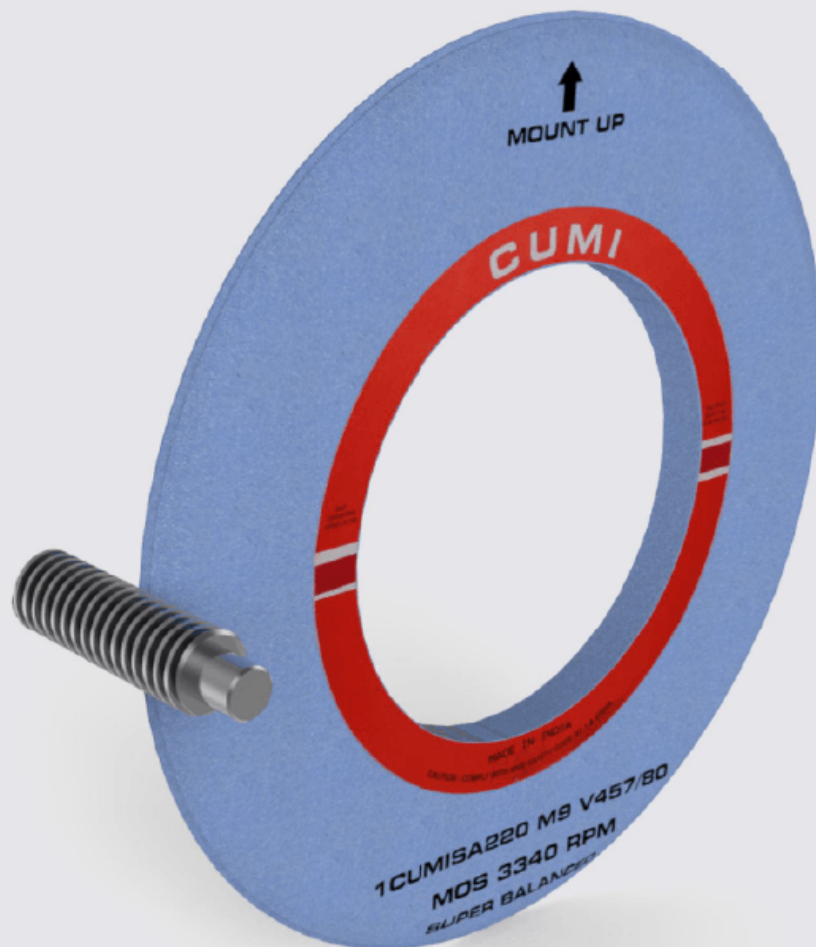

THREAD GRINDING WHEELS

ADVANTAGES OF CUMI WHEELS



1. Excellent form holding leading to reduced dressing
2. Low grinding forces
3. Minimal thermal load/
No burns on the taps
4. Lower cycle time
5. Higher wheel life

WIDTH OF PRODUCT RANGE

CUMI Code	Grit Range	Diameter		Thickness		Speed mps	Hardness	Structure
		mm	inch	mm	inch			
55A	120 - 220	200 - 510	8 - 20	6 - 40	1/4 to 11/2	upto 80	I - M	4 - 10
AA	120 - 400							
RA	Upto 150							



THREADED TAP

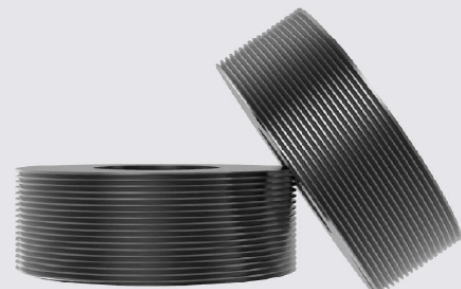

THREAD ROLL DIE

THREAD GRINDING WHEELS

TAPER ROLLER BEARING RING

Thread (pitch, mm)	Best	Better	Good
0.4 – 0.7	-	-	AA400 K9 VF920/80
0.8 – 1.0	-	55A320 K9 VF920/80	AA320 K9 VF920/80
1.25 – 1.5	-	-	AA280 L10 V457/80
1.75 – 2.0	-	55A220 J9 V457/80	AA240 L9 V457/80
2.25	1CUMISA220 K9 V457/80	55A220 K9 V457/80	AA220 M9 V457/80
2.50 - 3.00	1CUMISA180 L9 V457/80	55A180 K9 V457/80	AA180 M9 V457/80
3.25 -4.00	1CUMISA150 L9 V457/80	55A150 L8 V457/80	AA150 M9 V457/80

Thread (pitch,MM)	TPI	Grading
0.7	36	GC400 I5 VMG
0.8	32	
1	25	GC320 I5 VMG
1.25	50	
1.5	17	GC280 I5 VMG
1.75	15	
2	13	GC220 I5 VMG
2.5	10	
3.5	7	
4	6	

BONDED ABRASIVES FLUTE GRINDING WHEELS

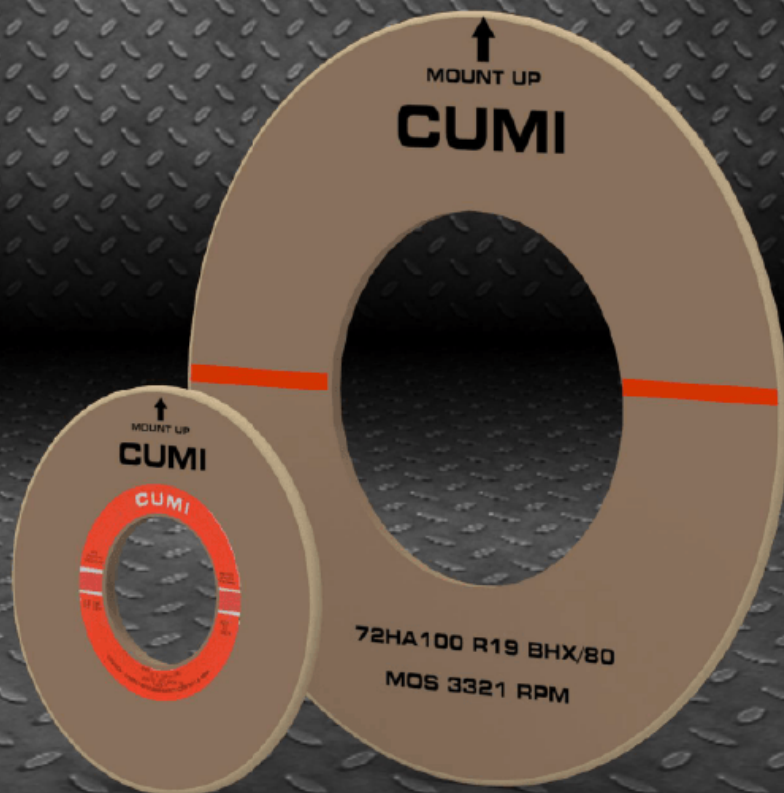

FLUTE GRINDING



BONDED ABRASIVES

FLUTE GRINDING WHEELS

ABOUT FLUTE GRINDING

Being a high depth of cut, form generating grinding process, Flute grinding operations are at high speeds and remove material at rates comparable to machining process rather than grinding. A combination of peripheral and surface grinding actions, the depth of cut, width of cut, form retention and surface finish are crucial parameters.

CUMI Flute grinding wheels are specially engineered high density (near zero porosity), resin bonded wheels which ensure that the form is generated with utmost precision and finesse. These wheels truly are a testament to the expertise that CUMI has built over the years.

FEATURES:

- Special phenolic resin
- Specially treated aluminium oxide grains for higher depth of cut
- Micro crystalline grain for lesser dressing frequency
- Unique manufacturing process for high density packing

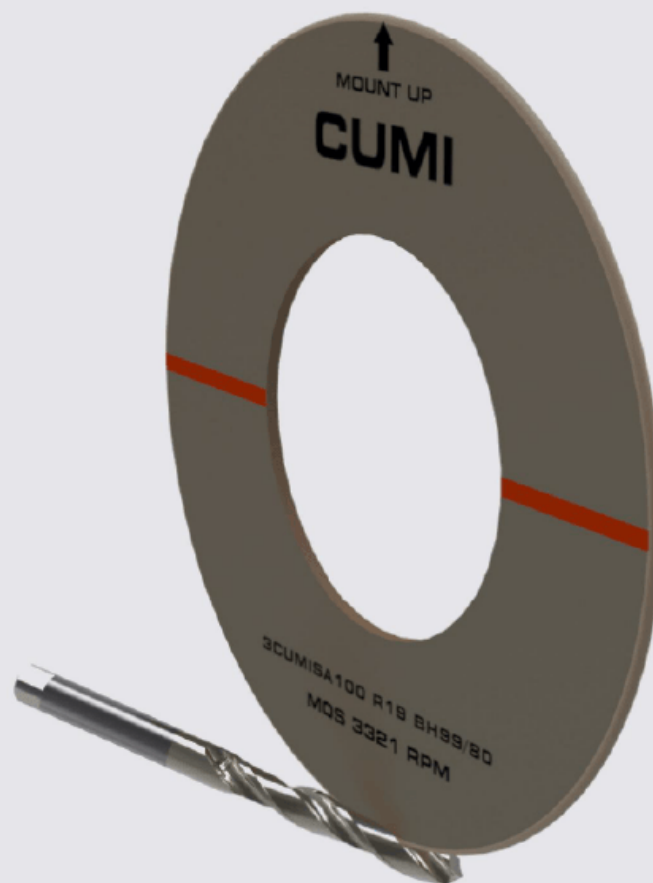

FLUTE GRINDING WHEELS

ADVANTAGES OF CUMI WHEELS



1. High depth of cut
2. Higher wheel life
3. Better form holding/
reduced dressing
4. Smoke free grinding
5. Burn free components

WIDTH OF PRODUCT RANGE

CUMI Code	Grit	Diameter		Thickness		Structure	Coolant slot	Speed
		mm	inch	mm	inch			mps
CUMISA/CSA	80 - 150	150 - 500	6 - 20	4 - 20	0.16 - 0.8	R P Q F	slotted	63
SA								
RA								
AA								

COMMONLY USED MACHINES:

- Normac
- Hertline
- Gefra

FLUTE GRINDING WHEELS

COMMONLY USED MACHINES

•Hertline •Normac •Gefra



DRILL



TAP

Operation	Component	Best	Better	Good
Flute grinding	Drills	3CUMISA100 R19 BH99/80	3CUMISA100 R19 BHX/80	3SA100 R19 BHK/80
Point grinding	Drills	-	-	AA100 S12 BHP/60 AA100 S12 BH47/80
Clearance grinding	Drills	3CUMISA100 Q24 BH99/80	3SA100 Q24 BH99/80	AA80 Q21 BH99/80

BONDED ABRASIVES

BALL GRINDING & LAPPING WHEELS

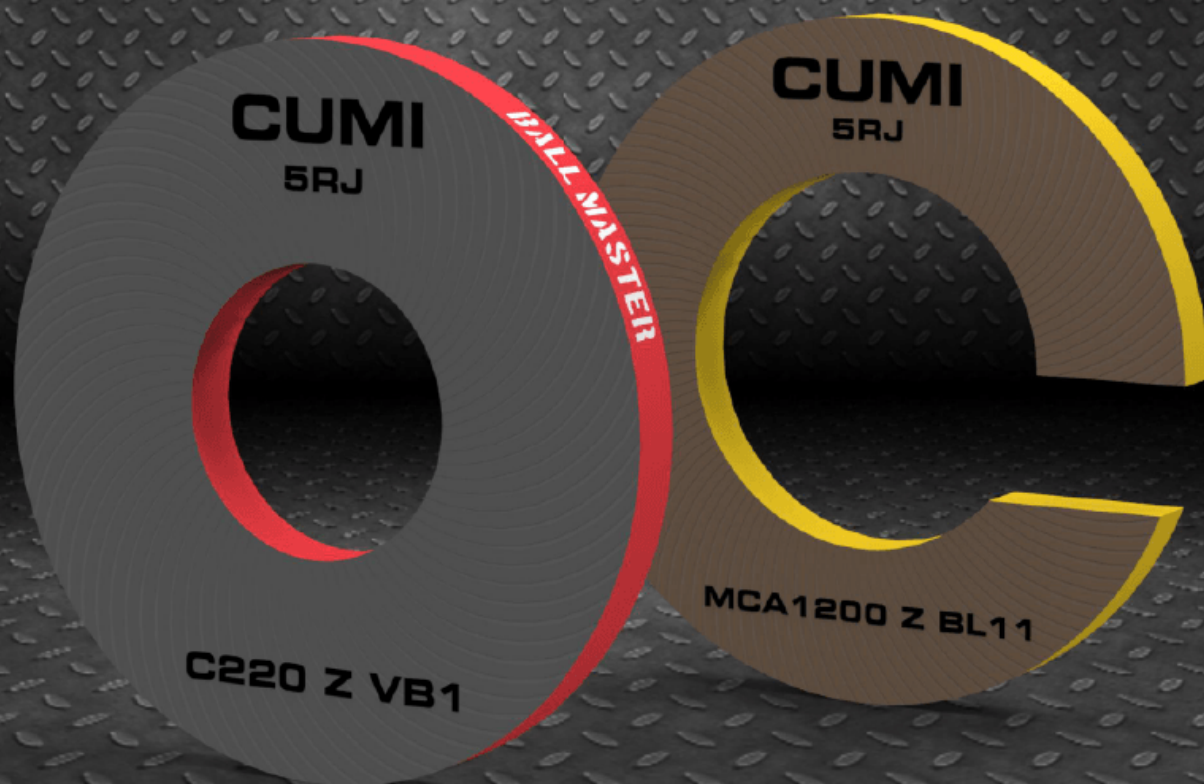

BALL GRINDING & LAPPING WHEELS

ABOUT BALL GRINDING & LAPPING WHEELS

The demands expected of balls in the Bearing industry have become highly stringent in terms of quality in the recent years. The primary objective of a ball manufacturer is to constantly improve quality of the balls, in terms of sphericity (roundness) and surface finish, while reducing the overall manufacturing cost.

CUMI provides best-in-class ball finishing solutions, customized to meet the exacting demands and ensure that premium quality balls are produced. Be it the High Density Vitrified wheels for Grinding or the Micro grit Resinoid wheels for Lapping, CUMI has got it all. The state of the art manufacturing facility ensures that every wheel produced meets stringent quality norms.

FEATURES

BALL GRINDING

- Conditioned and specially treated raw materials
- Unique bond system for defect free surface
- Specially controlled process for ensuring consistency (layer to layer & wheel to wheel)

BALL LAPPING

- Closely graded aluminium oxide grain for superior surface quality
- Unique hot press technology for ensuring consistency
- Modified resins to achieve high material removal rate and low wheel wear

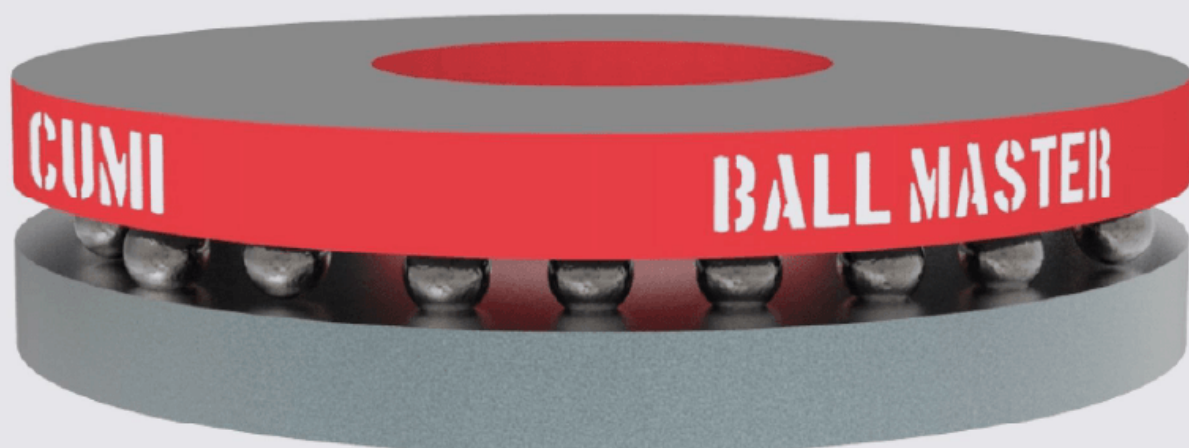

BALL GRINDING WHEELS

ADVANTAGES OF CUMI WHEELS

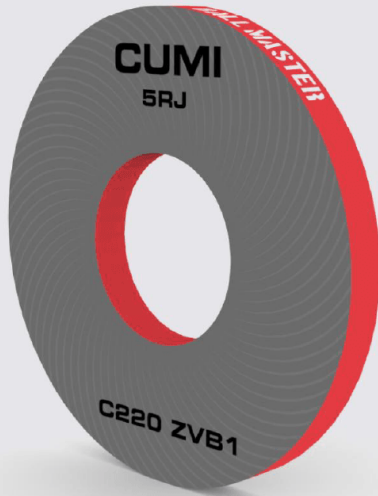

1. Faster cycle time
2. Consistent quality layer to layer
3. Longer wheel life
4. Superior ball quality
5. Overall low abrasive cost per ball

WIDTH OF PRODUCT RANGE

CUMI Code	Grit Range	Diameter		Thickness		Hardness
		mm	inch	mm	inch	
C	80-220	300-1000	12-40	40-140	1-1/2 to 5-1/2	v,x,y,z
	240-600	300-660	12-24	40-70	1-1/2 to 4	



BALL INDUSTRY

PRODUCT RECOMMENDATION

Operation	Ball Size		Diameter	Thickness	Hardness	Bond System	Grit Size	Grain Type
	mm	inch						
Rough	<=4mm	<=5/32"	660 - 1000	80 - 140	X - Y	Good - VB923 & Better : VB7 Best : VB	80 - 400	Black SIC
	>4mm - 11mm	>5/32" - 7/32"						
	12mm - 25mm	15/32" - 31/32"						
	>25mm	>32/32"						

Grinding Ratio	Hardness
Low	V
Medium	X
High	Z

Material Removal Rate	Toughness
High	1
Medium	3
Low	5

BALL LAPPING WHEELS

ADVANTAGES OF CUMI WHEELS



1. Unique process for product consistency
2. Longer wheel life
3. Excellent surface finish
4. Reduced lapping cost
5. Higher productivity due to high material removal rate

WIDTH OF PRODUCT RANGE

CUMI Code	Grit	Diameter		Thickness		Hardness	Structure
		mm	inch	mm	inch		
CA	320 - 1500	400 - 1000	16 - 40	30 - 140	1-1/4 to 5-1/2	Y, Z & Z+	4
AA	320 - 1500	400 - 1000	16 - 40	30 - 80	1-1/4 to 3-1/4	Y, Z & Z+	



BALL INDUSTRY

Operation	Lapping Stage	Grit Range	Hardness	Good	Better	Best
Lapping	1	G600 & G800	Y, Z & Z+	-	WA-BL15 WA-BL393	WA-BL15 WA-BL393
	2	G800 & G1000	Y, Z & Z+			
	3	G1200 & G1500	Y & Z			

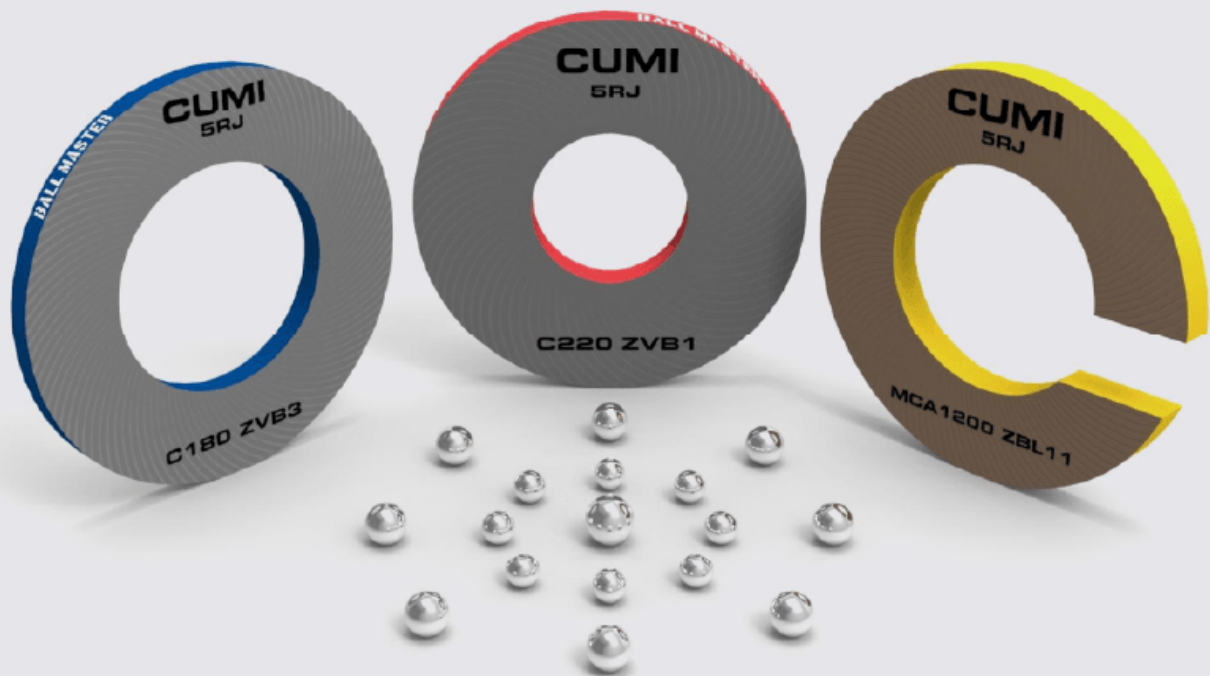

BONDED ABRASIVES CREEP-FEED GRINDING WHEELS



CREEP-FEED GRINDING



BONDED ABRASIVES

CREEP-FEED GRINDING WHEELS

ABOUT CREEP-FEED GRINDING WHEELS

Very high grinding allowances, and at the same time, superior surface finish requirements on the components; Although easy to describe, what is challenging in this application is the ability to maintain form, size and finish produced by the wheels while removing very high amount of stock.

CUMI offers Creep-feed grinding wheels which are designed to perform well in high material removal operations without compromise on the form and finish. Be it continuous dressing or conventional intermediate dressing, when it comes to Creep-feed grinding, CUMI wheels achieve reduced dressing by superior form holding while removing material at high feed rates.

FEATURES

- Free cutting abrasives
- Fusible, glassy bond for improved form holding
- Uniform large open pores for coolant flooding
- Advanced moulding technique for uniform mass distribution



CREEP-FEED GRINDING WHEELS

ADVANTAGES OF CUMI WHEELS

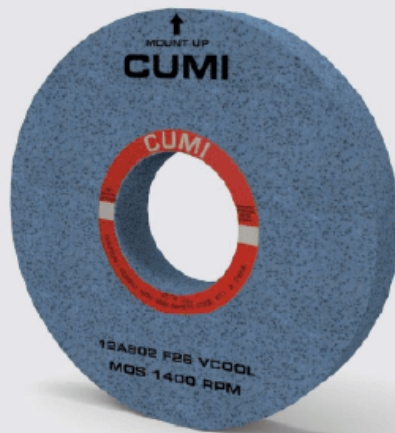

1. High feed rates for faster cycle time
2. Controlled wear and longer wheel life
3. Burn free surface
4. Easy on the Dressing roll
5. Good form holding leading to good geometry and dressing

WIDTH OF PRODUCT RANGE

CUMI Code	Grit Range	Diameter		Thickness		Speed mps	Hardness	Structure
		mm	Inch	mm	Inch			
SA	46 - 120	200 - 610	8 - 24	20 - 150	3/4 - 6	33	E - I	16 - 28
AA								
12A								

SHAPES

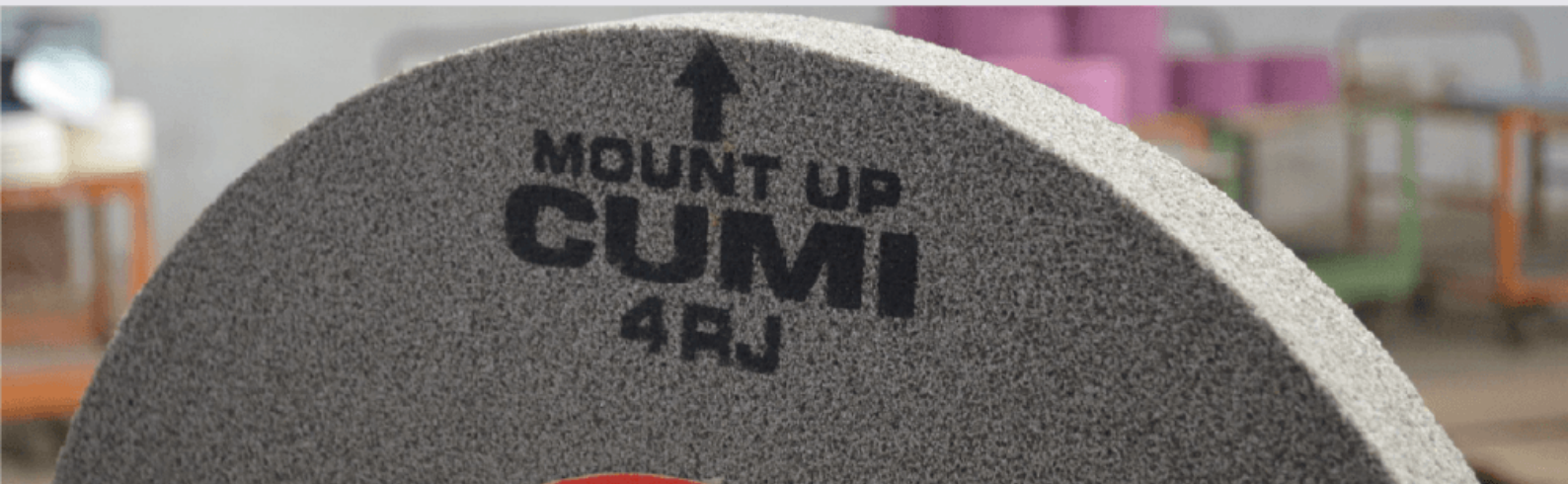
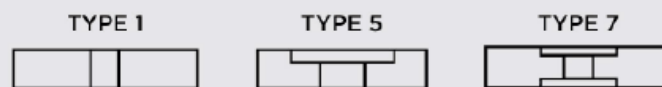

AEROSPACE

Material	Application	Operation	Best	Better	Good	Speed
Steel	Unhardened	Roughing	AA603 G28 V600	SA603 G28 V2020 AA603 G28 V2020Y	–	33
	Hardened	Roughing	AA603 F28 V600	SA603 F28 V2020, AA603 F28 V2020Y	–	

AUTOMOTIVE

Material	Component	Best	Better	Good
Alloy Steel	Tp Rotor	5SA803 F28 V2020	12A100 E29 VCOOL	ΔA100 F29 VMC
	Tp Rotor	5SA803 F28 V2020	5SA803 F26 VCOOL	AA80 F26 VMC
	Steering Rack	5SA463 E28 V2020	AA463 F28 V2020	ΔA46 F26 VMC
	Rocker arm	5SA463 E28 V2020	AA463 F28 V2020	AA46 F26 VMC
	Machine Guideway	5SA463 F28 V2020	RAA463 J23 VMPA	AA46 J16 VF8P

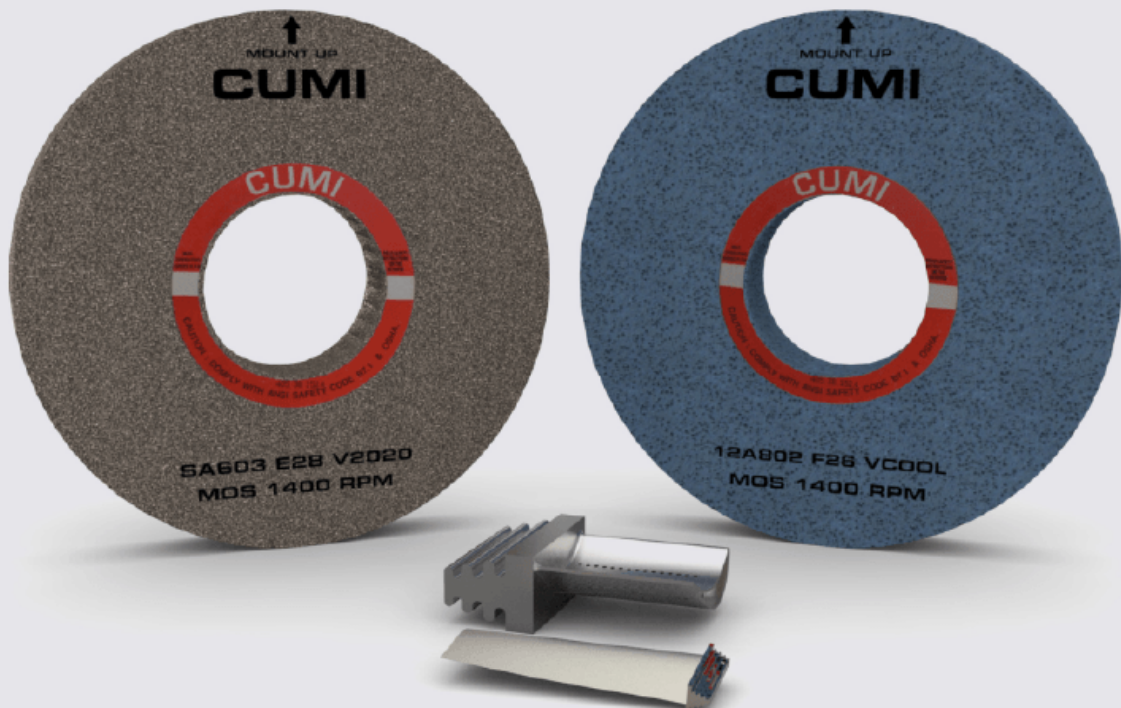

BONDED ABRASIVES GEAR GRINDING WHEELS

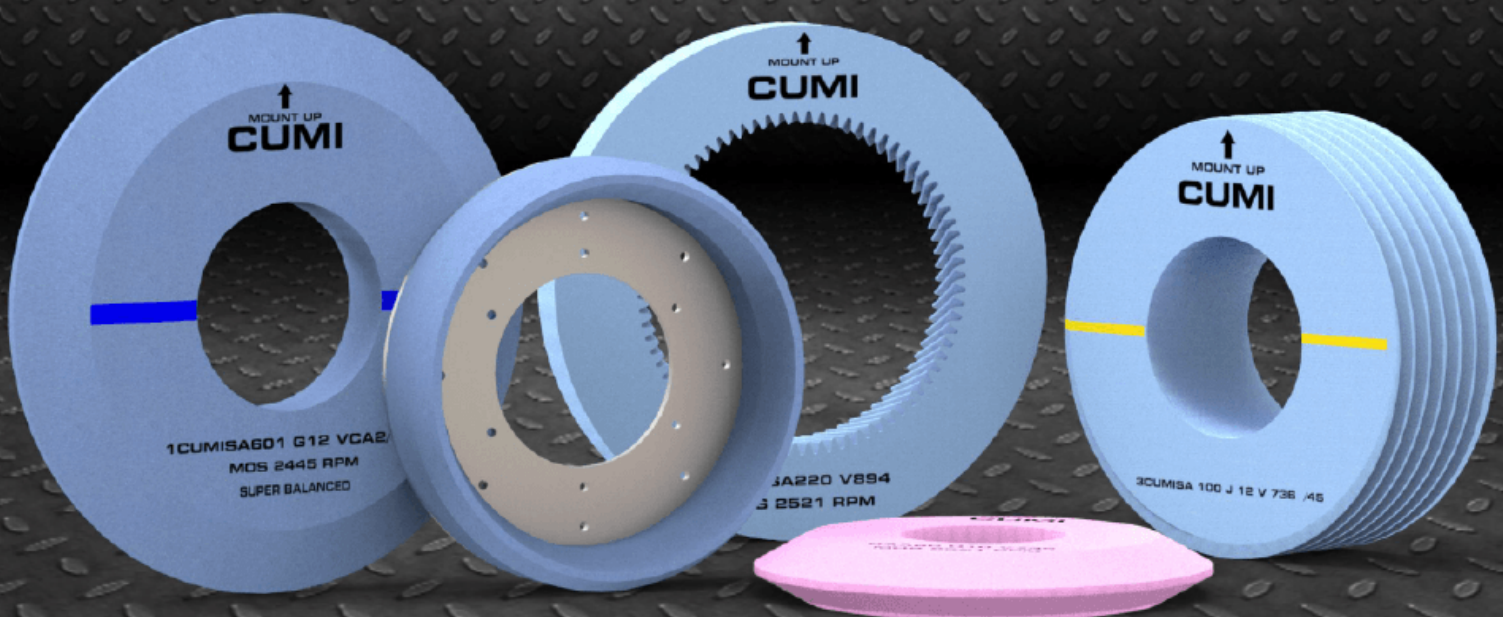

GEAR GRINDING



BONDED ABRASIVES

GEAR GRINDING WHEELS

ABOUT GEAR GRINDING WHEELS

One of the most advanced grinding applications, the sheer amount of parameters that are measured/controlled during the grinding of gears poses enough of a challenge to give abrasive manufacturers a run for their money. Intricate profile accuracy while maintaining high Material removal rates (Q') and Dressing frequency (V') are the major requirements in this application.

CUMI's Specially designed sharp crystalline grain combination and Krystal bond systems enable us to predict wheel wear patterns and thereby modify our wheels to ensure that the necessary profile and surface roughness is achieved consistently while maintaining low cycle times. While the combination ensures performance, our world class manufacturing set up makes sure that all the varieties of gear grinding like single rib, multi rib, bevel etc. are covered.

FEATURES

- Fusible, glassy crystalline bond for improved form holding
- Special filling, pressing and sintering process for uniform hardness across width
- High precision CNC profiling of wheel and inspection

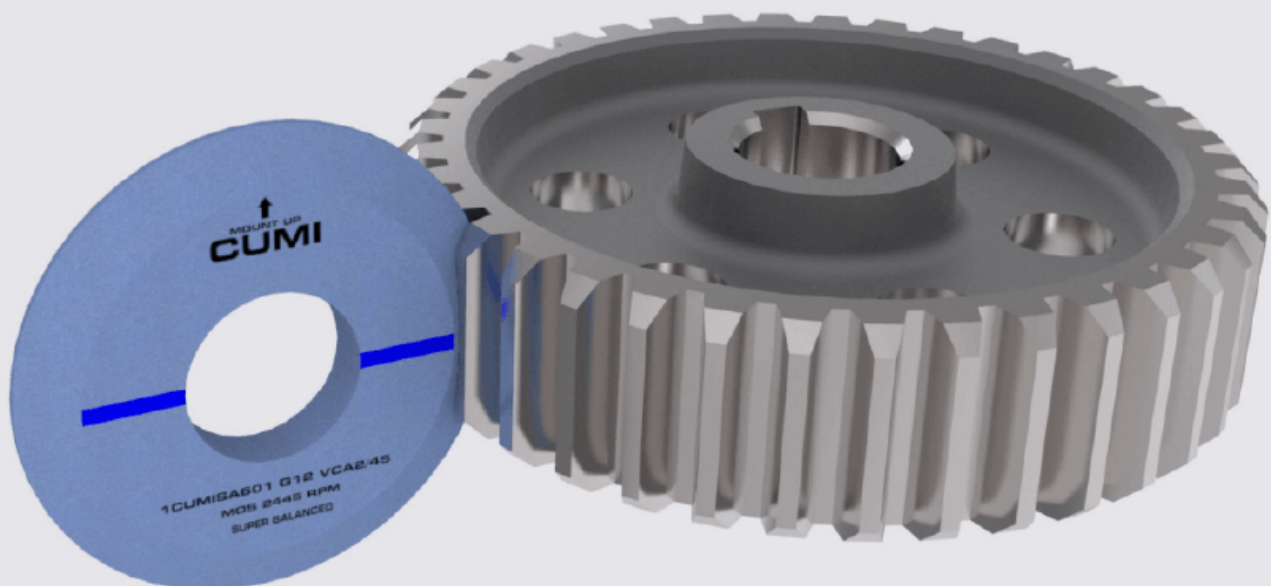

GEAR GRINDING WHEELS

ADVANTAGES OF CUMI WHEELS

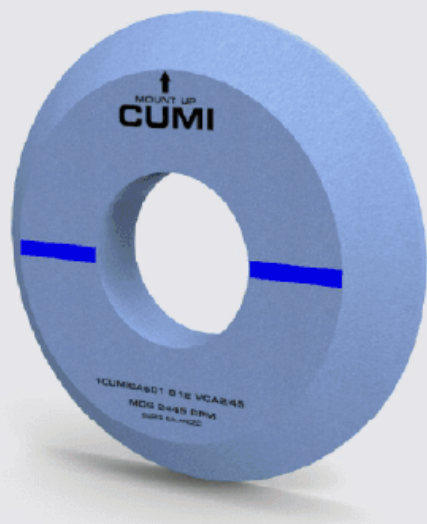

1. Burn free surface
2. High volume metric removal
3. Reduced dress depth and frequency
4. Good form holding for profile accuracy
5. Controlled wear and highly consistent performance throughout working life



SINGLE RIB GEAR GRINDING

WIDTH OF PRODUCT RANGE

CUMI Code	Grit Range	Diameter		Thickness		Speed	Hardness	Structure
		mm	inch	mm	inch	mps		
CUMISA/ CSA	46 - 120	80 - 508	3 1/4 - 20	10 - 150	3/8 - 6	35 & 50	G - J	8 - 18
70CN/ 70CSA								
55A								

COMMONLY USED MACHINES

- Niles • Hofler • MAAG
- Gleason-Pfauter • Samputensili

CONVENTIONAL PROCESS

Gear Module	Stock Removal	Best	Better	Good
Upto 8 M	Upto 5Q'W	3CUMISA801 G12 VCA2	55A801 G12 VCA2	RAA80 H10 V736
	Above 5 upto 15Q'W	72CN801 G18 VC600/50	3CUMISA801 G18 VCA2	1CUMISA801 G15 VCA2
Above 8 M	Upto 5Q'W	3CUMISA601 G13 VCA2	3CUMISA601 G13 VCA2	1CUMISA601 G13 VCA2
	Above 5 upto 15Q'w	72CN601 G18 VC600/50	3CUMISA601 G18 VCA2	1CUMISA601 G18 VCA2

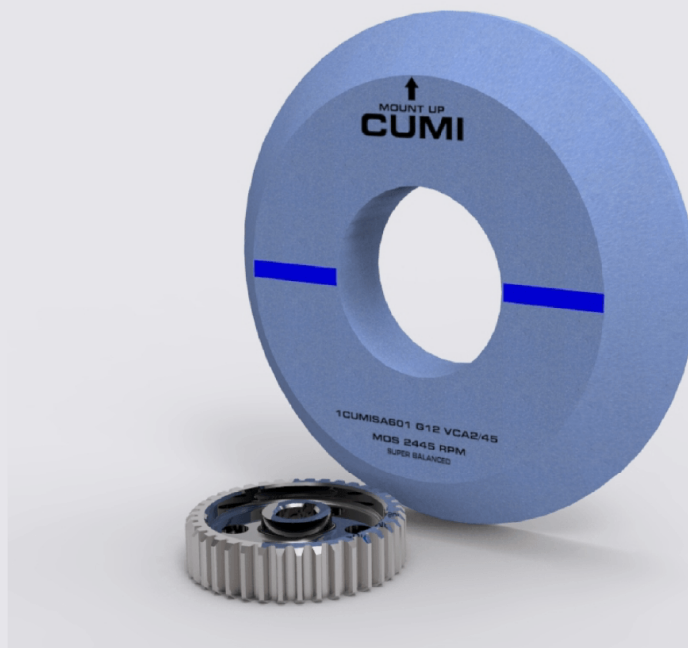

SINGLE RIB GEAR GRINDING

COMMONLY USED MACHINES

•Gleason •Pfauter •Samputensili •Hofler •Niles

Speed

CNC PROCESS

Gear Module	Stock Removal	Best	Better	Good
Upto 5 M	Upto 5Q'W	73CSA801 G15 VC600	72CSA801 G15 VC600	1CSA601 G12 VC600
	6Q' to 8Q'W	73CSA801 G15 VC600	72CSA801 G15 VC600	3CSA601 G13 VC600
	Above 8Q'	73CSA801 G18 VC600	72CSA801 G18 VC600	3CSA601 G13 VC600
6 to 8 M	Upto 5Q'W	72CN801 G15 VC600	72CSA801 G15 VC600	3CSA601 G13 VC600
	6Q' to 8Q'W	72CN801 G18 VC600	72CSA801 G18 VC600	3CSA601 G15 VC600
	Above 8Q'	72CN801 G20 VC600	72CSA801 G20 VC600	3CSA601 G18 VC600
Above 8 M	Upto 5Q'W	72CN801 G18 VC600	72CSA801 G18 VC600	3CSA601 G15 VC600
	6Q' to 8Q'W	72CN801 G20 VC600	72CSA801 G20 VC600	3CSA601 G18 VC600
	Above 8Q'	72CN801 G28 VC600	72CSA801 G28 VC600	3CSA601 G20 VC600

MULTI RIB GEAR GRINDING

WIDTH OF PRODUCT RANGE

CUMI Code	Structure	Speed	Grit Range	Diameter		Thickness		Hardness
		mps		mm	inch	mm	inch	
CN	10 - 13	50, 63 & 80	80 - 120	250 - 400	10 - 16	80 - 250	31/4 - 10	I - K
CUMISA/ CSA								
24R	10 - 13	50, 63 & 80						
SA	5 - 7	35 & 50	60 - 180					

COMMONLY USED MACHINES

- Reishauer (ZB/OZA/AZA/NZA/ RZ series) • Kapp
- Leibherr • Buri • Samputensili • Mitsubishi • Nidec

CONVENTIONAL PROCESS

Gear Module	Best	Better	Good
upto 1.5 M	1CUMISA120 V736/50	-	RA120 I12 V736/50
1.75 M - 2.25 M	3CUMISA100 I12 V736 /50	-	SA100 I7 V677/50
2.5 M - 4 M	3CUMISA 80 I12 V736 /50	-	SA 80 K5 V677/50
Above 4.25 M	3CUMISA 80 J12 V736 /50	-	SA 60 K5 V677/50

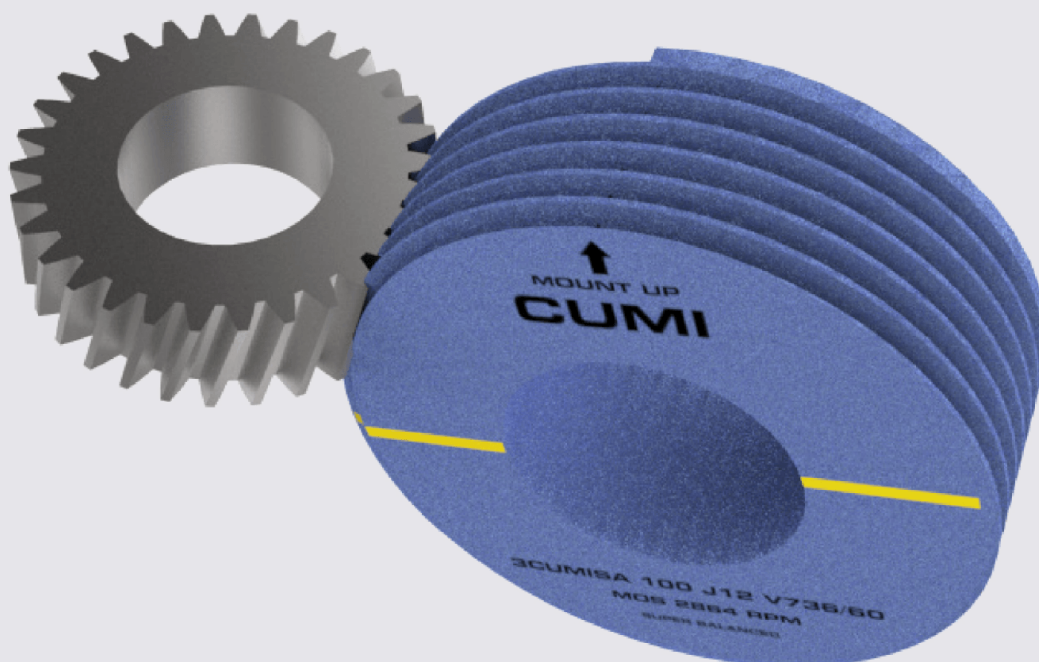

MULTI RIB GEAR GRINDING

COMMONLY USED MACHINES

- Reishauer RZ301S, RZ361S, RZ362A
- Liebherr (LCS200 / LC280)
- Kapp •Gleason •Pfauter •Samputensili

CNC PROCESS

Gear Module	Best	Better	Good
upto 1.5 M	2CN120 I12 V736/80	3CSA120 I12 V736/80	24R120 I12 V736/80
1.75 M - 2.25 M	2CN100 J12 V736/80	3CSA100 J12 V736/80	24R100 J12 V736/80
2.5 M - 4 M	2CN80 J12 V736/80	3CSA80 J12 V736/80	24R80 J12 V736/80
Above 4.25 M	2CN80 J12 V736/80	3CSA80 J12 V736/80	24R80 J12 V736/80

SHAVING CUTTER

WIDTH OF PRODUCT RANGE

CUMI Code	Grit Range	Diameter		Thickness		Hardness	Structure	Speed
		mm	inch	mm	inch			
53A	100 - 120	750 - 800	29 1/2 - 31 1/2	20 - 50	3/4 - 2	G - I	10 - 13	35
RA						I - K	5 - 8	
AA								

COMMONLY USED MACHINES

- Hurth • Mitsubishi

Process	Best	Better	Good
Shaving Cutter	53A120 G13 VCA2	RA120 G6 TDV155	AA100 H8 VF8



HONING & HOB RE-SHARPENING

WIDTH OF PRODUCT RANGE

CUMI Code	Grit Range	Diameter		Thickness		Hardness	Structure	Speed
		mm	inch	mm	inch			mps
CUMISA	80 - 220	80 - 508	3 1/4 - 20	10 - 50	3/8 - 2	I - K	6 - 8	35 & 50
73CSA								
RAA								

COMMONLY USED MACHINES

- Prawema •SyncroFine •Gleason-Hurth •Fassler
- Seiwa •Emag •Kapp •Kanzaki Power

Type	Specification
Vitrified honing	CUMISA220 V894
Epoxy resin honing	CUMISA180 E895

Type	Best	Better	Good
Hob Re-sharpening	73CSA60 G15 VC600	3CSA80 G12 VC600	RAA60 H12 V736

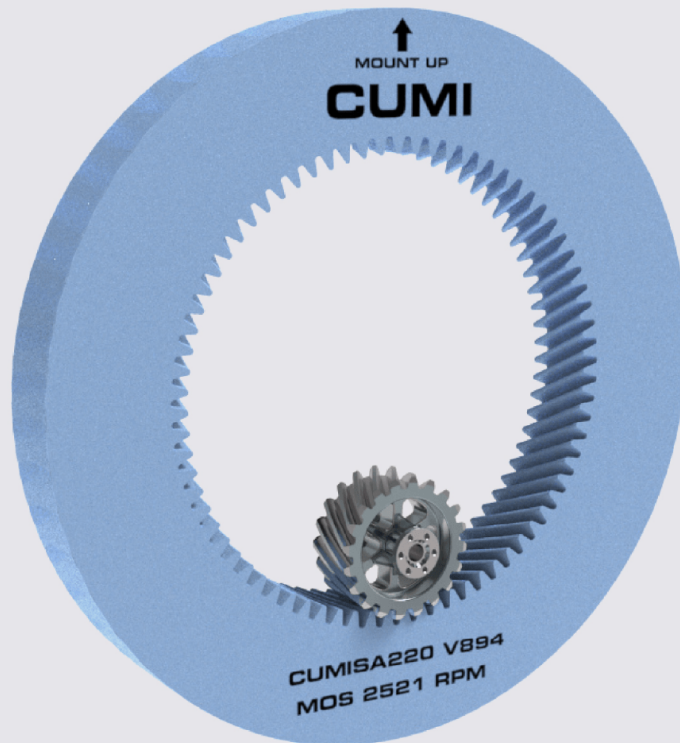

BONDED ABRASIVES

ROLL GRINDING WHEELS



ROLL GRINDING WHEELS



BONDED ABRASIVES

ROLL GRINDING WHEELS

ABOUT ROLL GRINDING WHEELS

Although a simple cylindrical grinding application, what makes Roll grinding challenging is the volume of stock removed from rolls, which are difficult to grind. The length of roll also provides a challenge for the wheel to retain its size and form during the traverse grinding process. Maintaining high grinding ratios/ roll reduction values is crucial in these applications, as they have a direct effect on the overall cost and cycle time.

CUMI Roll Grinding wheels combine the latest developments in resin bond technology along with suitable grain combination to give the optimal balance between cutting action and wheel life without compromising on the quality parameters.

FEATURES

- Hi performance Microcrystalline abrasive blended with Silicon Carbide grains
- Special phenolic resins for high wear resistance
- Modular manufacturing facility
- Controlled curing process



ROLL GRINDING WHEELS

ADVANTAGES OF CUMI WHEELS



1. High feed rates for faster cycle times
2. Controlled wear (High Grinding ratios)
3. Excellent surface quality
4. Spiral & Scratch free finish for Cold rolling applications
5. Consistent performance throughout working life

WIDTH OF PRODUCT RANGE

CUMI Code	Grit Range	Diameter		Thickness		Speed mps	Hardness	Structure
		mm	inch	mm	inch			
CE	36 - 120	610 - 1100	24 - 1/64 to 43 - 5/16	60 - 150	2 - 23/64 to 5 - 29/32	45	I - K	5 - 7
SA								
AA								
A								
GC								

SHAPES



STEEL

HOT STRIP MILL

Type of Roll	Speed	Best	Better	Good
Work Roll	50	3CE30 J6 B1363/50	–	GC361 B112R 4
Back up Roll		3CE30 J6 B1363/50	–	A30 J5 B384

COLD STRIP MILL

Type of Roll	Speed	Best	Better	Good
Work Roll	50	3CE60 K5 B384R	DA60 K5 B384R/50	A60 K5 B384
Back up Roll		-	DA46 J5 B384R	A46 J5 B384



ROLL GRINDING

CUMI

BONDED ABRASIVES

BONDED ABRASIVES SNAGGING WHEELS

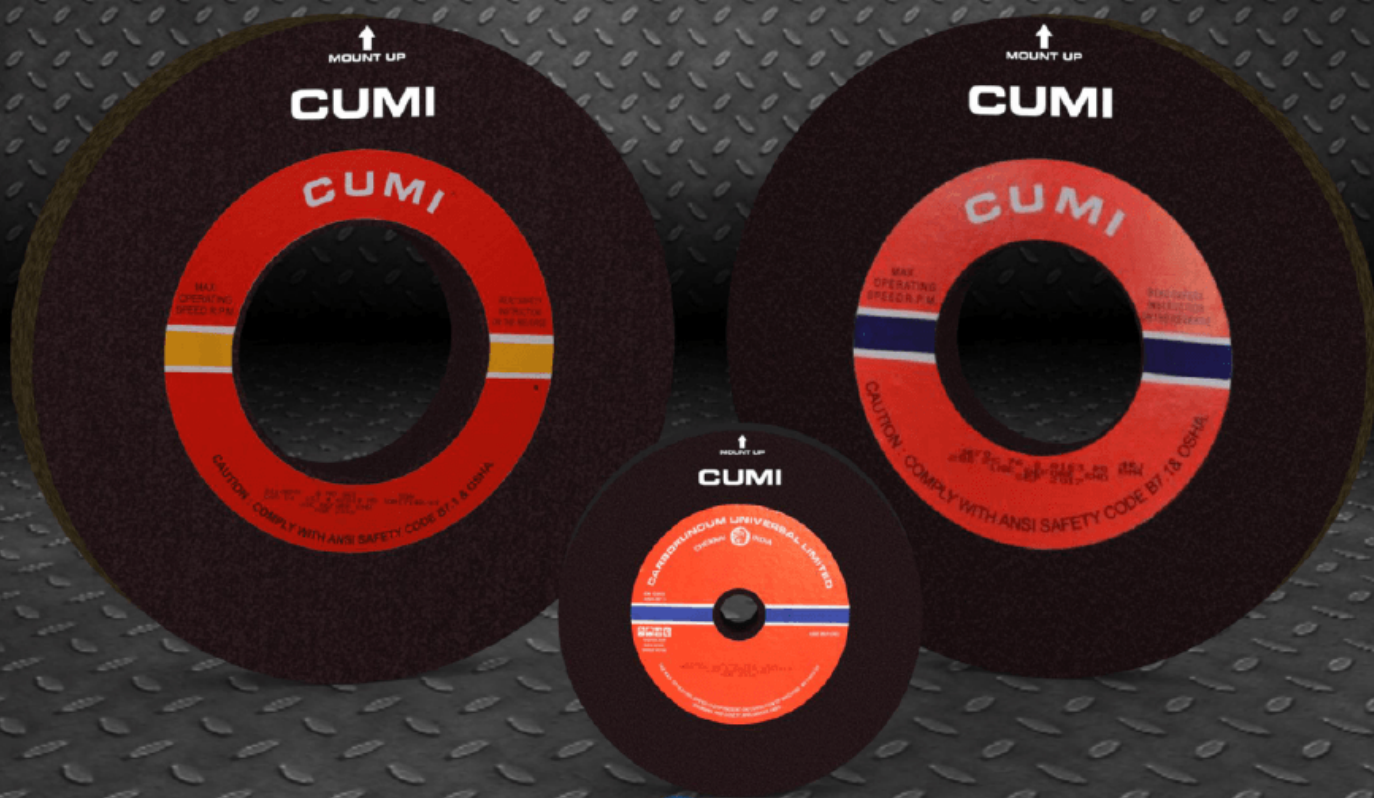

SNAGGING WHEELS



BONDED ABRASIVES

SNAGGING / FETTLING WHEELS

ABOUT SNAGGING / FETTLING WHEELS

One of the roughest and toughest applications in the industry, snagging operations focus primarily on the material removal rates. With high wheel speeds and manual grinding involved, the product design calls for robustness that gives utmost safety while addressing the material removal requirements of the user.

CUMI wheels stand up to this tough task, thanks to a rugged combination of specially formulated resins and toughened grains. The reinforced bores ensure that the product is extremely safety use in spite of the rugged nature of the applications

FEATURES:

- Rounded, tough abrasives
- Strong and tough resin bond for durability
- Grinding aids for cool cutting
- High accuracy finishing of wheels for better geometry



SNAGGING WHEELS

ADVANTAGES OF CUMI WHEELS



1. Excellent cutting action
2. Higher productivity
3. Controlled wear and longer wheel life
4. Burn free surface
5. Unparalleled safety

SHAPES

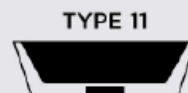

PORTABLE SNAGGING WHEEL

WIDTH OF PRODUCT RANGE

CUMI Code	Grit Range	Diameter		Thickness		Speed	Hardness	Structure
		mm	inch	mm	inch	mps		
AZA	12 - 24	50 - 200	2 - 8	10 - 25	1/64 - 1	50	M - R	2 - 9
CA	14 - 24							
C								
A								

Type of Roll	Speed	For Better Life	For Better MRR
Carbon Steel & Low Alloy Steel	50	A163 R3 TDR1215	A163 R5 BM4
High Alloy Steel & Stainless Steel		A163 R2 BM4	A163 Q5 BM4
Hi-Chrome Steel		AZA163 TDR1175	AZA143 TDR1214
Grey Cast Iron & SG Iron		C163 Q3 B1551	CA163 TDR1219

PEDESTAL & SWING FRAME SNAGGING WHEEL

WIDTH OF PRODUCT RANGE

CUMI Code	Grit Range	Diameter		Thickness		Speed	Hardness	Structure
		mm	inch	mm	inch	mps		
AZA	12 - 24	300 - 750	12 - 30	25 - 100	1 - 4	50	P - T	2 - 8
CA	14 - 20							
C								
A, 14A								

Wheel Type	Type	Speed	For Better Life	For Better MRR
PEDESTAL	Carbon Steel & Low Alloy Steel	50	A163 R2 TDR1215	A163 TDR1220
	High Alloy Steel & Stainless Steel		A163 R2 BM4	A163 R5 BM4
	Hi-Chrome Steel		AZA123 TDR1175	AZA143 TDR1214
	Manganese Steel		14A16 P3 B1322	
	Grey Cast Iron & SG Iron		CA145 TDR505C	CA163 TDR1219
SWING FRAME	Carbon Steel & Low Alloy Steel	50	A163 S3 TDR1215	A163 TDR1220
	High Alloy Steel & Stainless Steel		A143 TD722	A163 TDR1220
	Hi-Chrome Steel		AZA123 TDR1175	AZA143 TDR1214
	Manganese Steel		14A16 P3 B1322	
	Grey Cast Iron & SG Iron		C163 T3 BSG	CA163 TDR1219
SWING FRAME	Titanium Alloy steel	63	AC20 P7 BF1551/63 (Reinforced with Glass Fabric for enhanced safety)	AZC20 Q7 BF1551/63 (Reinforced with Glass Fabric for enhanced safety)
PEDESTAL / SWING FRAME	High performance Cast Iron / SG Iron	63	CUMI NXT CAZA143 U BHT54 (Special Process for enhanced safety)	CUMI NXT CAZA143 U BHT64 (Special Process for enhanced safety)

BONDED ABRASIVES

CUP WHEEL GRINDING

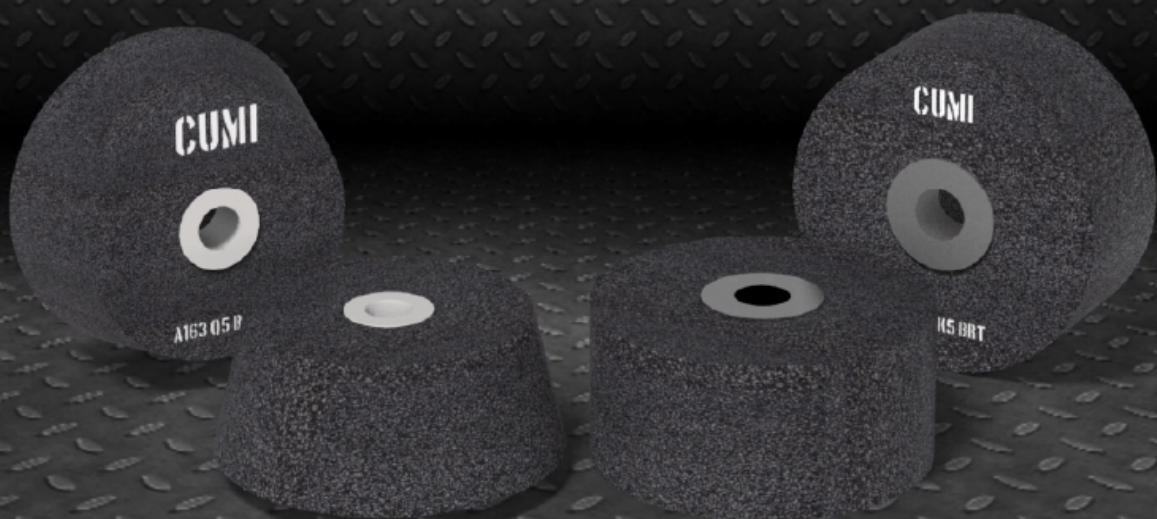

CUP WHEEL GRINDING



BONDED ABRASIVES

CUP WHEEL GRINDING

ABOUT CUP WHEEL GRINDING

CUMI's Cup wheels are designed for grinding of stone and welded joints of metal by means of portable grinders.

Available in both straight and tapered shapes, CUMI's Cup wheels are available in a wide range of grit sizes from Grit 16 to Grit 220 to meet all grinding / finishing needs.

FEATURES:

- Threaded nut insert for easy mounting
- High strength phenolic resin for better safety
- Unique grinding aids for cooler cutting action
- Advanced manufacturing facility for better control of geometry and wheel vibration
- High performance zirconia grains for heavy duty grinding

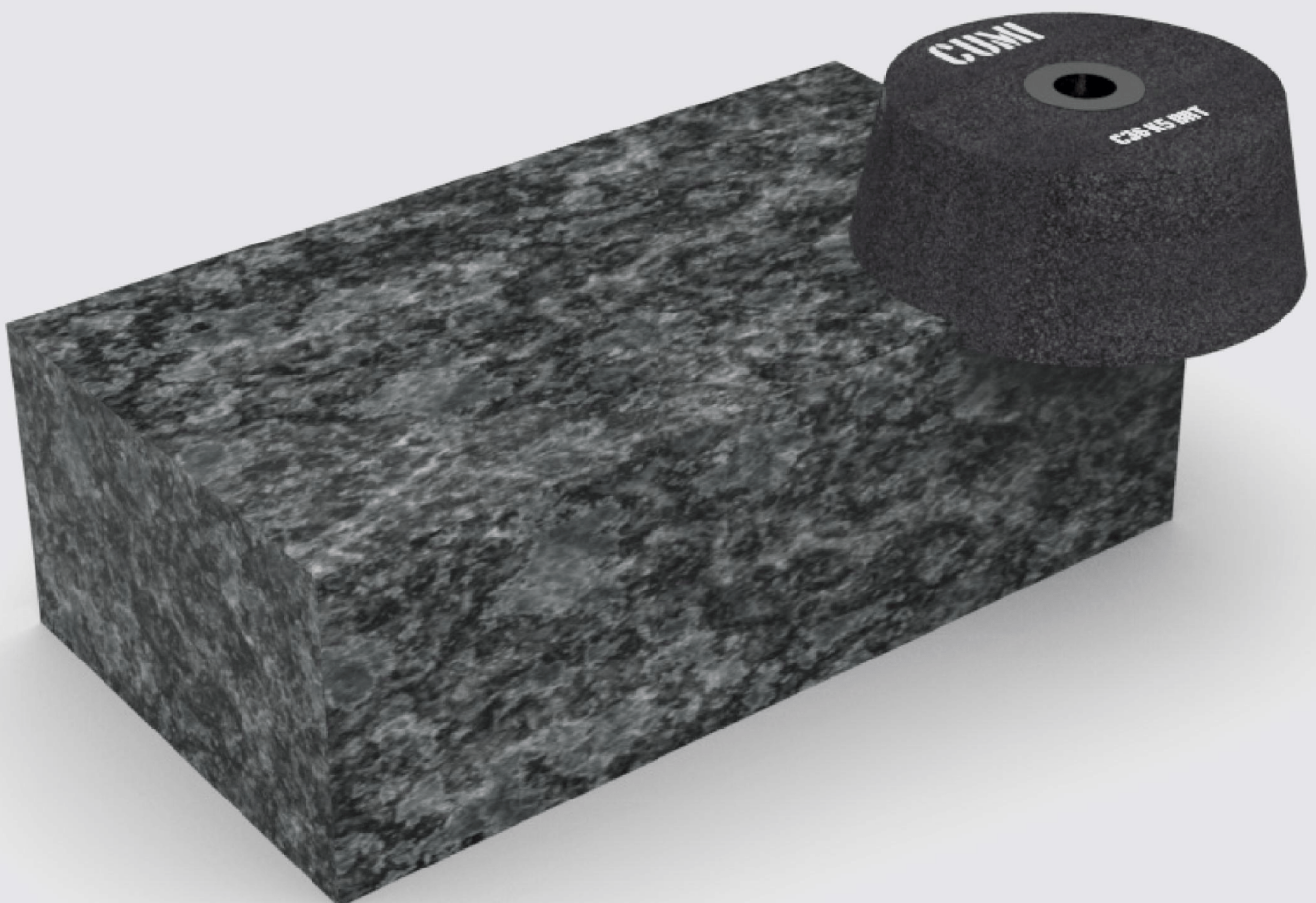

CUP WHEEL GRINDING

ADVANTAGES OF CUMI WHEELS



1. Fast cut rate
2. Smooth running
3. Long tool life
4. No vibrations
5. Burn free & smooth finish

SHAPES



METAL

WIDTH OF PRODUCT RANGE

CUMI Code	Grit Range	Diameter		Thickness		Speed	Hardness	Structure
		mm	inch	mm	inch	mps		
AZA	12 - 24	100 - 200	4 - 8	50 - 100	2 - 4	50	M - R	2 - 9
CA	14 - 24							
C								
A								

Variant	Type	Speed	For Better Life	For Better MRR
Portable	Carbon Steel & Low Alloy Steel	50	A163 R3 TDR1215	A163 R5 BM4
	High Alloy Steel & Stainless Steel		A163 R2 BM4	A163 Q5 BM4
	Hi-Chrome Steel		AZA163 TDR1175	AZA143 TDR1214
	Grey Cast Iron & SG Iron		C163 Q3 B1551	CA163 TDR1219

STONE

WIDTH OF PRODUCT RANGE

CUMI Code	Grit Range	Diameter		Thickness		Speed	Hardness	Structure
		mm	inch	mm	inch	mps		
C	24 - 220	100 - 127	4 - 5	38 - 63.5	1 1/2 - 2 1/2	50	J - L	5 - 6

Variant	Type	Speed	Recommendation
Portable	Marble	50	C36 K5 BRT
	Granite		



BONDED ABRASIVES TOOL ROOM GRINDING WHEELS



TOOL ROOM GRINDING



BONDED ABRASIVES

TOOL ROOM GRINDING WHEELS

ABOUT TOOL ROOM GRINDING WHEELS

Tool room grinding wheels find vast applications in the manufacture and regrinding of cutting tools like drills, reamers, milling cutters etc.,

CUMI's tool room wheels are available in like plain wheels (type 1), cup wheels (type 6 & 11), dish wheels (type 12), saucer wheels (type 13). They are available in both dry and wet grinding applications

FEATURES:

- Right choice of abrasive grain for specific materials
- Unique bond system for cool grinding and wheel form retention

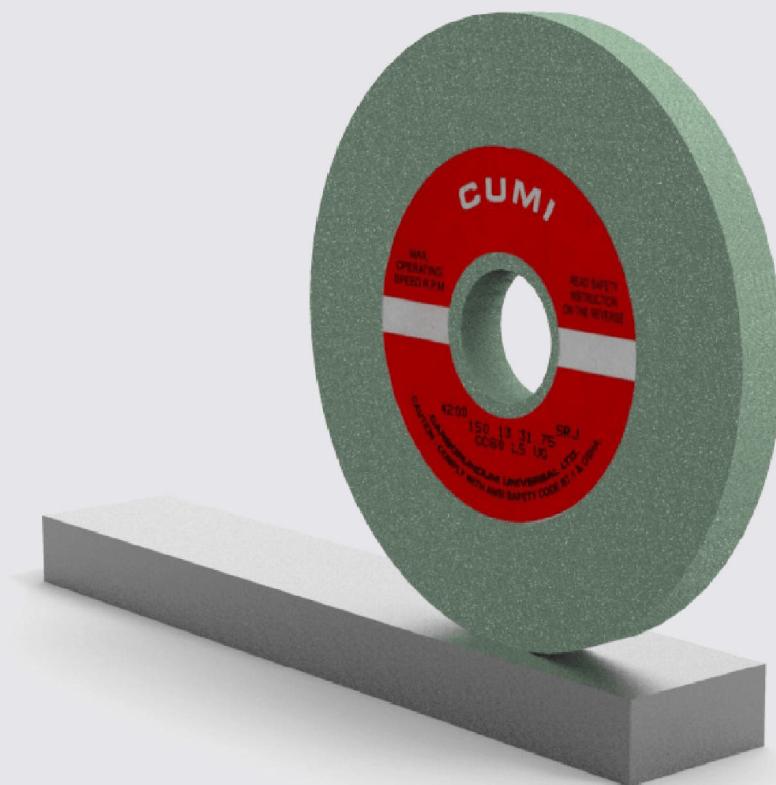

TOOL ROOM GRINDING WHEELS

ADVANTAGES OF CUMI WHEELS



1. High productivity
2. Excellent form retention
3. Dimensional accuracy
4. Surface finish
5. Burn free component

WIDTH OF PRODUCT RANGE

CUMI Code	Grit Range	Diameter		Thickness		Speed mps	Hardness	Structure
		mm	inch	mm	inch			
CUMISA	46 - 120	80 - 250	3 1/8 - 9	3 - 25	1/8 - 1	35 & 50	I - L	5 - 7
RA/RAA								
12A								
AA								
GC								
CGC								

SHAPES

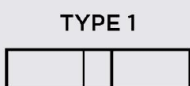

TOOL ROOM GRINDING WHEELS

Material	Operation	Speed	Best	Better	Good
High Speed Steel / Tool Steel / High Alloy Steel	Rough	35	1CUMISA46 J6 VC500	RA46/54 J6 V206	AA46/54 K5 V8
		50	1CUMISA46 J6 VC500 /50	RA46/54 J6 V206/50	AA46/54 K5 V50
	Finish	35	1CUMISA60 J6 VC500	RA60 J6 V206	AA60 K5 V8
		50	1CUMISA60 J6 VC500 /50	RA60 J6 V206/50	AA60 K5 V50
Tungsten Carbide		35	GC60 K5 VS2110	GC60 K5 VG	CGC60 K5 VG
		50	GC60 K5 VS2110/50	GC60 K5 VG/50	CGC60 K5 VG/50
Special Tool Steels	Rough	35	1CUMISA461 J7 VC500	55A461 J7 VC500	RAA46/54 J6 V206
		50	1CUMISA461 J7 VC500/50	55A461 J7 VC500/50	RAA46/54 J6 V206/50
	Finish	35	1CUMISA60 J7 VC500	55A60 J7 VC500	RAA60 J6 V206
		50	1CUMISA60 J7 VC500/50	55A60 J7 VC500/50	RAA60 J6 V206/50

HEAD - INTERNATIONAL BUSINESS
VIPIN MALIK

✉ malikvipin@cumi.murugappa.com

📞 vipin0810

📞 +91 97910 14577

📞 +91 44 3000 6194

SURESH V

SENIOR GENERAL MANAGER

655, Thiruvottiyur High Rd, Periyar Nagar,
Tiruvottiyur, Chennai, Tamil Nadu 600019.

+91- 9789990492 📞

sureshv@cumi.murugappa.com ✉

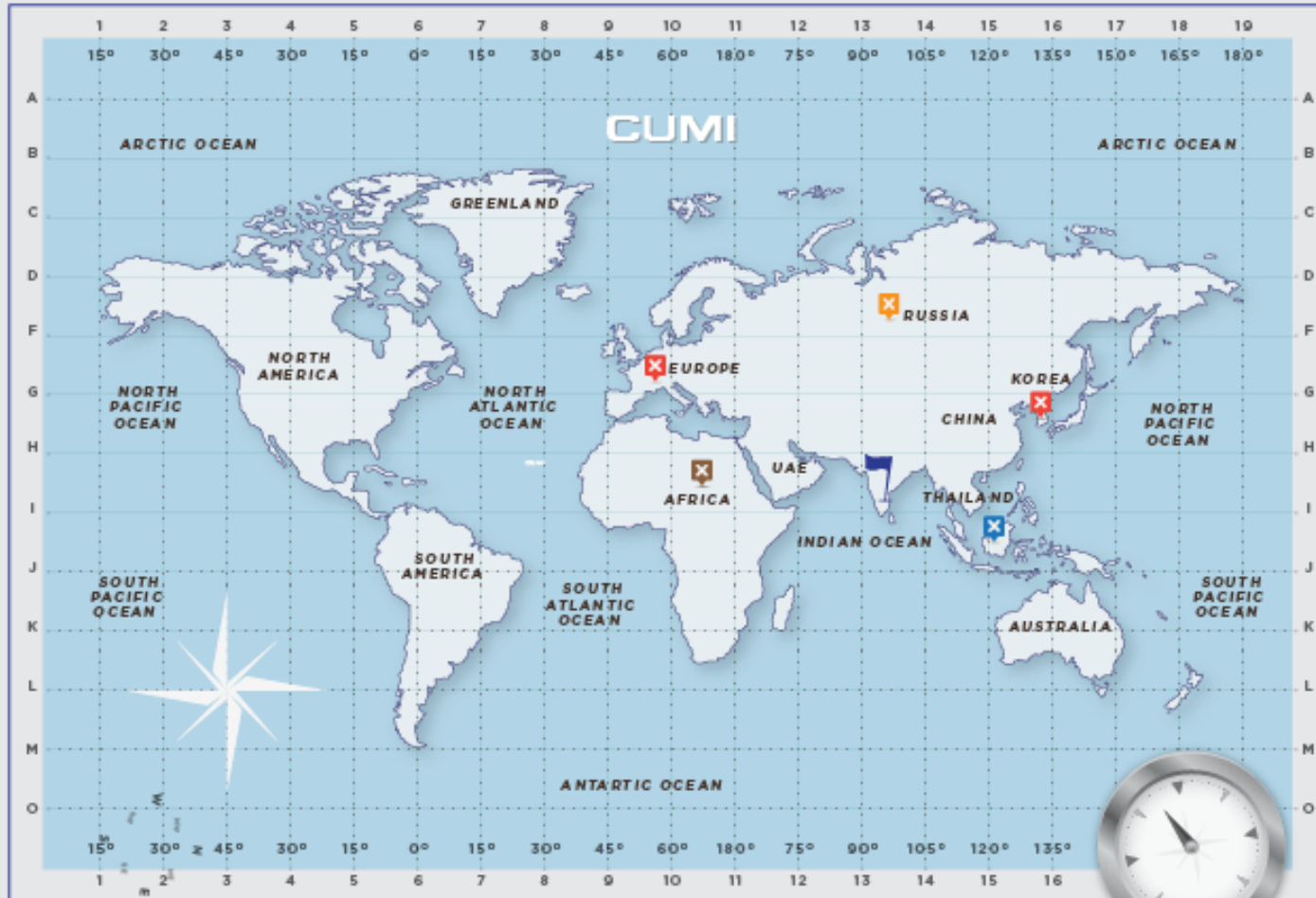

USA

CUMI America Inc.

1119 AVIATION BLVD, HEBRON, KY 41048, US

+1 844 CUMI USA (+1 844 286 4872)

+1 859 372 6606

+1 859 372 6607

nbichkar@cumiusa.com, rsmith@cumiusa.com

MIDDLE EAST

CUMI Middle East Fze, 315, Business Center 3,

P.O. Box 16190, Rak Free Trade Zone, UAE

+971-7-2046181

+971-562226190 / +91-9874686688

+971-7-2046182

sumonroy@cumi.murugappa.com





CARBORUNDUM UNIVERSAL LIMITED

Parry House, No.43, Moore Street, 3rd Floor,

Chennai 600 001, India

Tel: +91 44 3000 6194 (Direct)

Fax: +91 44 3000 6191

www.cumiabrasives.com